

HS5241-0

Confectioneerbare connector

Connector M8 × 1 / Ø 8 mm, haaks

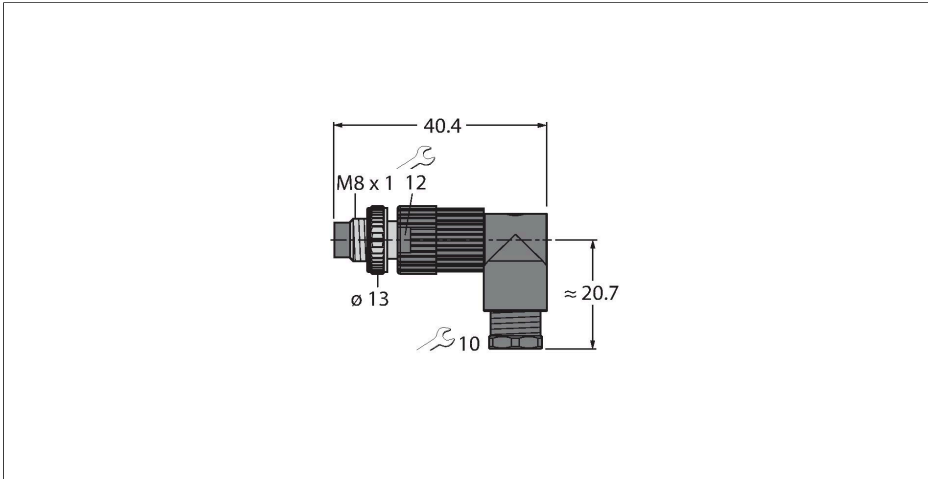

Kenmerken



- Metalen montagevoer
- Beschermingsklasse IP67
- Penetratietechniek
- 4-polig
- metr. schroefdraad M9,5 x 1

Contactconfiguratie



Technische gegevens

Type	HS5241-0
Identnr.	6902830
Connector A	Connector, M8 × 1, Haaks
Aantal polen	4
Contacten	CuZn, Verguld
Contactdrager	Kunststof, PA, Zwart
Greep	PA, Zwart
Wartelmoer/-bout	Zink-aluminium, ZnAl, Vernikkeld
Dichtingsring	Kunststof, FPM/FKM
Schroefdraad	M9.5x1
Externe diameter van de leiding	4...5 mm
Aderdoorsnede/klemvermogen	0.14...0.34 mm ²
Aansluittype	indringingstechniek
Beschermingsklasse	IP67, (geschroefd)
Elektrische eigenschappen bij +20 °C	
Nominale spanning	50 V _{AC} /60 V _{DC}
Stroombelastbaarheid	4 A
Isolatiweerstand	≥ 10 ⁸ Ω
Elektrische weerstand	≤ 5 mΩ
Mechanische en chemische eigenschappen	
in rusttoestand	-25...+70 °C