

# HT-IDENT-H1147

## HF Read/Write Head – For Manual Operation

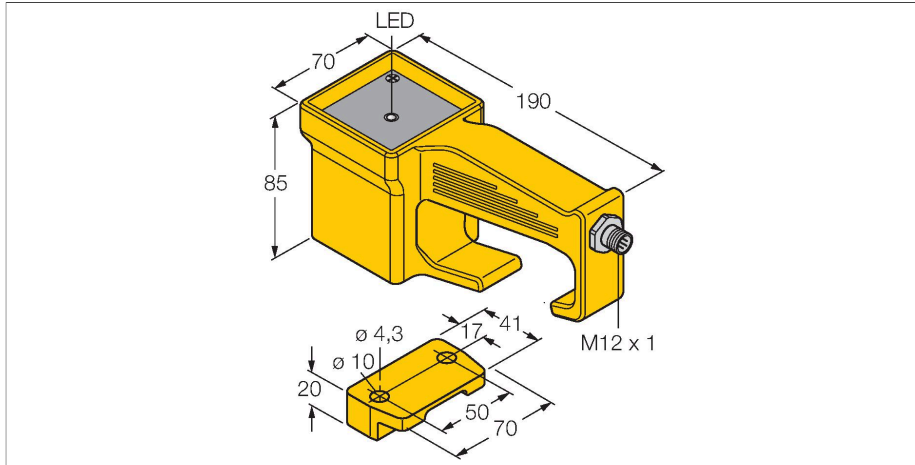

### Technical data

Type	HT-IDENT-H1147
ID	7030236
Remark to product	Flexible use
Approvals	CE UKCA
Radio approvals	EU/RED: Europe
<b>Electrical data</b>	
Operating voltage	10...30 VDC
DC rated operational current	≤ 80 mA
inrush current	1000 mA For: 1 ms
Data transfer	Inductive coupling
Technology	HF RFID
Operating frequency	13.56 MHz
Radio communication and protocol standards	ISO 15693 NFC Typ 5
Read/Write distance max.	115 mm
Output function	4-wire, Read/Write
<b>Mechanical data</b>	
Mounting conditions	Non-flush
Ambient temperature	-25...+70 °C
Design	Grip, HT-IDENT
Dimensions	190 x 70 x 85 mm
Housing material	Yellow
Active area material	Plastic, yellow
Vibration resistance	55 Hz (1 mm)
Shock resistance	30 g (11 ms)
Protection class	IP67
Electrical connection	M12 × 1

### Features

- Powered and operated only via connection to BL ident interface module
- M12 × 1 connector, connection only via BL ident extension cable

### .../S2503 Connectors

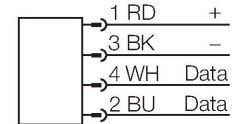

### .../S2500 Connectors

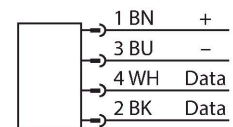

### .../S2501 Connectors

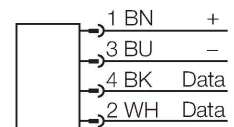

### Functional principle

The HF read/write devices operating at a frequency of 13.56 MHz form a transmission zone, the size of which (0...500 mm) varies depending on the combination of read/write device and tag used.  
The read/write distances mentioned here only represent standard values measured under



## Technical data

MTTF	248 years acc. to SN 29500 (Ed. 99) 40 °C
Power-on indication	LED, Green
Packaging unit	1

laboratory conditions, free from any influences caused by surrounding materials.  
 The read/write distances of the tags for mounting in metal TW-R\*\*-M(MF) were determined in metal.  
 Attainable distances may vary by up to 30 % due to component tolerances, mounting conditions, ambient conditions and material qualities (especially when mounted in metal).  
 Testing of the application under real operating conditions is therefore essential, especially with on-the-fly reading and writing!

LED	Color	Status	Meaning
-----	-------	--------	---------

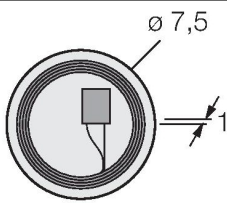
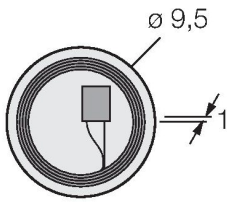
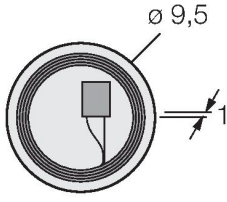
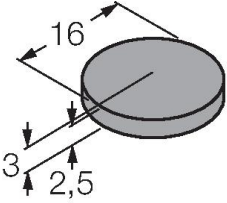
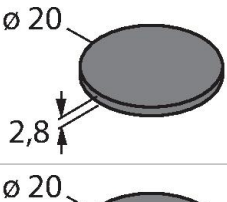
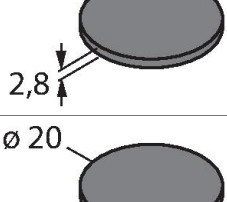
\\Graphics\Pic4\00185369\_0.EPS

Dimensions	Type designation	Read-write distance		Transfer zone		Minimum distance between two read-write heads [mm]
		Recommended (mm)	max. [mm]	length max. [mm]	width offset max. [mm]	
	<b>TW-R7.5-B128</b> 7030231	13	30	42	21	120
	<b>TW-R9.5-B128</b> 7030252	14	33	46	23	120
	<b>TW-R9.5-K2</b> 7030558	18	38	42	21	120
	<b>TW-R16-B128</b> 6900501	28	50	54	27	120
	<b>TW-R20-B128</b> 6900502	30	50	50	25	120
	<b>TW-R20-B320</b> 100005244	30	50	50	25	120
	<b>TW-R20-K2</b> 6900505	22	40	36	18	120

	<b>TW-R30-B128</b> 6900503	30	53	62	31	120
	<b>TW-R30-B320</b> 100005245	30	53	62	31	120
	<b>TW-R30-K2</b> 6900506	30	55	56	28	120
	<b>TW-R50-B128</b> 6900504	45	85	96	48	120
	<b>TW-R50-B320</b> 100005246	45	85	96	48	120
	<b>TW-R50-K2</b> 6900507	38	81	82	41	120
	<b>TW-L80-50-P-B128</b> 7030389	42	81	93	46	120
	<b>TW-B510X1.5-19-K2</b> 6901380	8	23	30	15	120
	<b>TW-BD10X1.5-19-K2</b> 6901381	20	39	44	22	120
	<b>TW-SPP18X1-B128</b> 6901062	15	34	46	23	120
	<b>TW-R50-M-B128</b> 7030209	23	46	48	24	120
	<b>TW-R80-M-B128</b> 7030207	25	53	68	34	120

	<b>TW-R50-M-K2</b> 7030229	15	37	46	23	120
	<b>TW-R80-M-K2</b> 7030205	15	47	54	27	120
	<b>TW-R4-22-B128</b> 7030237	20	40	50	25	120
	<b>TW-L86-54-C-B128</b> 6900479	60	115	132	66	120
	<b>TW-R10-M-B146</b> 7030545	7	18	30	15	120
	<b>TW-R12-M-B146</b> 7030500	7	18	30	15	120
	<b>TW-L18-18-F-B128</b> 7030634	29	56	52	26	120
	<b>TW-BS8x1.25-19-K2</b> 7030638	8	23	30	15	120