

TL50C5AKQ

LED Indicator – Compact Signal Tower

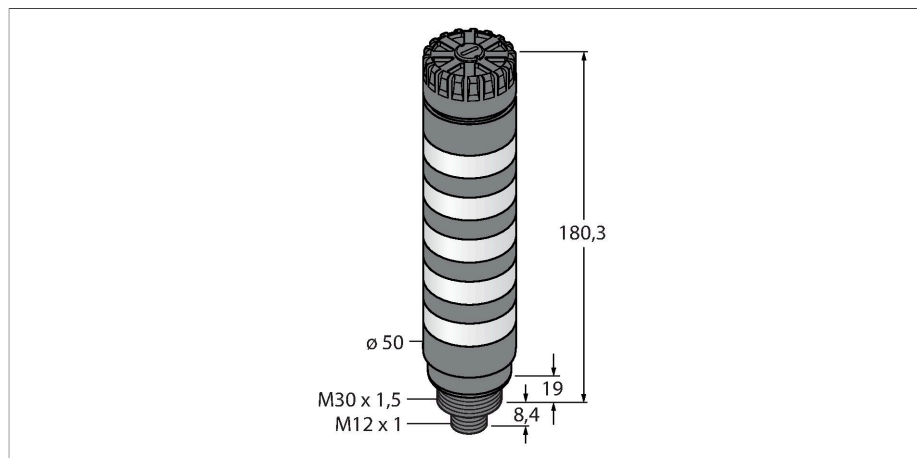

Features

- Plastic housing, black
- EMI and RFI immune
- Protection class IP50
- M12 x 1 male
- Flexible display with RGB LEDs
- Control of user-defined or predefined light colors
- Flashing function, alternation, two-colored display and intensity check
- Control and parametrization exclusively via IO-Link

Wiring diagram



Technical data

Type	TL50C5AKQ
ID	3804962
Signal and display data	
Purpose	LED indicator light
Function	Tower light
Light type	RGB
Dimmable	Programmable
Features of color 1	RGB, Programmable
Acoustic signal	Continuous tone, 92 dB
Electrical data	
Operating voltage	12...30 VDC
DC rated operational current	≤ 675 mA
Operating voltage	21...27 VAC
Max. current consumption per color	100 mA
Max. current consumption of beeper	25 mA
Communication protocol	IO-Link
Input type	Communication protocol
Response time typical	< 20 ms
IO-Link	
IO-Link specification	V 1.1
Communication mode	COM 2 (38.4 kBaud)
Process data width	16 bit
Frame type	Type_2_2
Function pin 4	IO-Link
Maximum cable length	20 m
Included in the SIDI GSDML	Yes

Functional principle

The TL50 Pro IO-Link tower lights provide highly visible status displays and clear user guidance throughout the entire system. Each tower light is assembled from RGB LED elements and is available with or without beeper. They are ready to use in just a few steps and can be mounted directly on machines, on the switch cabinet or in locations to be monitored within production lines. The corresponding RGB LEDs are parameterized via an IO-Link interface. This allows predefined colors and user-defined colors within the RGB color space to be controlled, with or without lighting animations. The lighting animations include a flashing function, intensity check, rotation, alternation and two-colored displays. Compared with the standard TL50 variants, the TL50 Pro IO-Link tower lights allow a variety of models to be implemented using just one display.

Technical data

Mechanical data	
Cascadable	No
Design	Smooth barrel, TL50C
Dimensions	Ø 50 x 207.7 mm
Housing material	Plastic, ABS, Black
Window material	Polycarbonate, diffuse
Electrical connection	Connector, M12 × 1, PVC
Number of cores	4
Ambient temperature	-20...+50 °C
Relative humidity	0...95 %
Protection class	IP50
Tests/approvals	
Approvals	CE, UL listed

Accessories

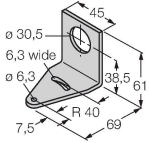
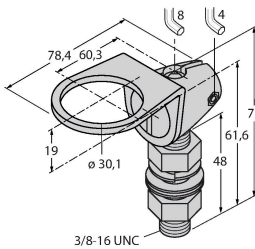
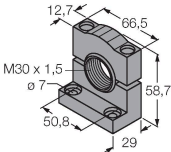
SMB30A	3032723	Mounting bracket, rectangular, stainless steel, for sensors with 30mm thread	SMB30FA	3074005	Montagewinkel; Werkstoff VA 1.4401
					
SMB30SC	3052521	Mounting bracket, PBT black, for sensors with 30 mm thread, rotatable			
					

Accessories

Dimension drawing	Type	ID	
	RKC4.4T-2/TEL	6625013	Connection cable, M12 female connector, straight, 4-pin, cable length: 2 m, jacket material: PVC, black; cULus approval

Dimension drawing

Type

WKC4.4T-2/TEL

ID

6625025

Connection cable, M12 female connector, angled, 4-pin, cable length: 2 m, jacket material: PVC, black; cULus approval

