

Accessories

Shaft Coupling Bellows Coupling

For Solid Shaft Encoders

RA-BC-E-20-10-10

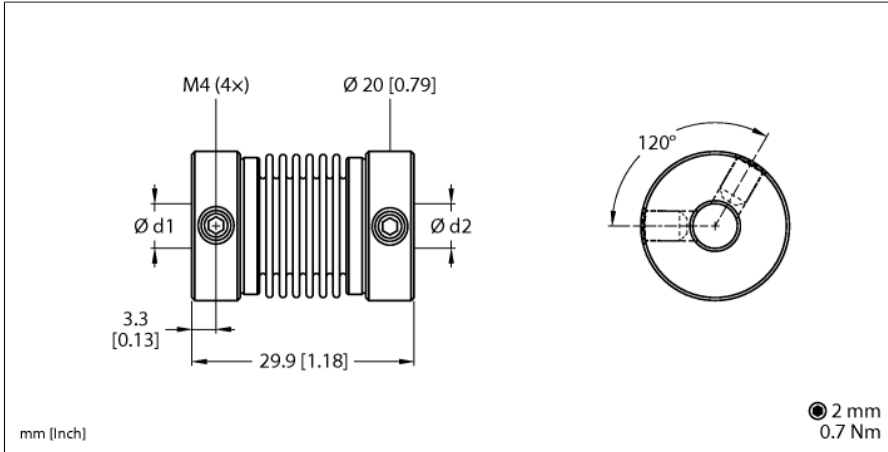

Type	RA-BC-E-20-10-10
ID	100048787
Max. rotational speed	10,000 rpm
Ambient temperature	-40...+200 °C

Bellows coupling made of stainless steel Ø 20 mm
 Max. torque: 120 Ncm
 Max. shaft offset:
 Radial: ±0.25 mm
 Axial: ±0.4 mm
 Angular: ±4°
 Torsion spring stiffness: 150 Nm/wheel
 Radial spring stiffness: 25 N/mm
 Moment of inertia: 18 gcm²
 Receptacle material: Stainless steel, 1.4404
 Bellows material: Stainless steel, 1.4571
 Bore diameter d1 = 10 mm, d2 = 10 mm