

SX5 Safety Laser Scanner

Instruction Manual

Original Instructions
208913 Rev. A
29 November 2018
© Banner Engineering Corp. All rights reserved



208913

Contents

1 About This Document	5
1.1 Important . . . Read This Before Proceeding!	5
1.2 Use of Warnings and Cautions	5
1.3 EU Declaration of Conformity (DoC)	5
2 Product Overview	6
2.1 Models	6
2.1.1 Features	7
2.1.2 Scanner Limitations	7
2.1.3 Product Specification Label	8
2.2 Documents List	8
2.3 Appropriate Applications and Limitations	8
2.3.1 Appropriate Applications	9
2.3.2 Control Reliability: Redundancy and Self-Checking	10
2.3.3 Application Checklist	10
2.3.4 Sample Applications	10
2.4 Operating Features	16
2.5 Reference Points (Surface) Monitoring	16
2.6 Passwords	17
2.7 Laser Safety (Class 1)	17
2.7.1 Class 1 Lasers	17
2.7.2 For Safe Laser Use (Class 1 or Class 2):	18
2.8 Software Overview	18
2.8.1 System Requirements	18
2.8.2 Safety and Warning Zones	19
2.8.3 Monitored Space Display	19
2.9 Security Protocol	19
2.10 General Safety Information	19
2.11 Specifications	20
2.11.1 Specifications	20
2.11.2 Dimensions	21
3 Install Your Scanner	22
3.1 Safety Zone (SZ) and Warning Zone (WZ) Considerations	22
3.2 Mechanical Installation Considerations	22
3.2.1 Unmonitored Areas	23
3.2.2 Adjacent SX5s	25
3.2.3 Light Interference	26
3.2.4 Highly Reflective Backgrounds	27
3.2.5 Limited Detection Capability Zone	27
3.2.6 Dust Filtering	28
3.3 Positioning Horizontal Safety Zones for Stationary Applications	28
3.4 Minimum Safety (Separation) Distance for Stationary Applications	29
3.5 Minimum Safety (Separation) Distance Formula	30
3.6 Reducing or Eliminating Pass-Through Hazards	31
3.7 Reset Switch Location	32
3.8 Supplemental Safeguarding	32
3.9 Mobile Applications	33
3.9.1 Safety Zone Area - Length and Width	34
3.9.2 Minimum Distance D (Safety Zone Length) for Mobile Applications	34
3.9.3 Additional Distance Factors (Z) Specific for Mobile Applications	35
3.10 Mounting Your Scanner for Mobile Applications	36
3.10.1 Mounting the Scanner Directly to a Surface	37
3.10.2 Mounting the Protection Bracket	37
3.10.3 Mounting the Angle Adjustment Brackets	37
3.10.4 Mounting the Scanner and Adjusting the Angle	38
3.10.5 Adjusting the Roll Angle	39
3.10.6 Scanner Mounting Safety Information	39
4 Electrical Connections	41
4.1 Routing Cordsets	41
4.2 Initial Electrical Connections	42
4.3 Electrical Connections to the Guarded Machine	42
4.3.1 Connecting the OSSD Outputs	42
4.3.2 Connecting the FSD Interfacing	43
4.3.3 Machine Primary Control Elements and External Device Monitoring	44
4.3.4 Warning (Auxiliary) Output	45

4.3.5 Preparing for System Operation	45
4.3.6 Machine Interface Connections	45
4.3.7 Wiring Diagrams	46
5 Initial Checkout	49
5.1 Apply Initial Power and Configure the Scanner	49
5.2 Verify the Optical Field (Initial Verification)	49
5.3 Perform a Trip Test	50
6 Configuration Instructions	53
6.1 System Configuration Settings	53
6.1.1 Response Time and Scan Cycle Setting	53
6.1.2 Automatic or Manual Start/Restart	53
6.2 Muting Functions	54
6.2.1 Mute Devices	54
6.2.2 Mute Device Requirements	54
6.2.3 Examples of Muting Sensors and Switches	55
6.2.4 Mute Enable (ME)	55
6.2.5 Mute Lamp Output	56
6.2.6 Mute Time Limit (Backdoor Timer)	56
6.2.7 Mute-Dependent Override	56
6.2.8 Muting Function T (X) (Bidirectional) or L (Unidirectional) Selection	57
6.3 Install the SX5soft Software	59
6.4 Software Interface	59
6.4.1 Main Menu	60
6.4.2 Toolbar	60
6.4.3 Status Bar	60
6.4.4 Task Selection	61
6.5 Using the Software	61
6.5.1 Output Configuration	63
6.5.2 Zone Set	64
6.5.3 Input Configuration	67
6.5.4 Detection Configuration	69
6.5.5 Create or Edit Safety and Warning Zones	70
6.5.6 Use TEACH In to Assign Safety and Warning Zones	71
6.5.7 Protecting a Vertical Area (Reference Points)	71
6.5.8 Connect a Scanner to a PC (Discover the Scanner)	71
6.5.9 Validate and Accept the Configuration	72
6.5.10 Monitor the Scanner	73
6.5.11 Save a Configuration File	73
6.5.12 Edit an Existing Configuration	73
6.5.13 Wink Function	74
6.6 Print the Safety System Report	74
6.7 Change the Password	75
6.8 Reset the Password	75
6.9 Configure a Static IP Address	75
7 Operating Instructions	76
7.1 Status Indicators	76
7.2 Display Menu	76
7.3 Resetting the System	76
7.3.1 Reset Signal Function	77
8 Checkout Procedures	78
8.1 Periodic Checkout Requirements	78
8.2 Schedule of Checkouts	78
8.3 Perform a Commissioning Checkout	79
8.4 Daily Checkout Procedure	80
8.5 Semi-Annual Checkout Procedure	81
9 Troubleshooting	82
9.1 Initial Troubleshooting Steps	82
9.2 Troubleshooting Lockout Conditions	82
9.3 Display Icons	82
9.4 Diagnostic Notes, Warnings, and Errors	83
9.5 Safety	85
9.6 Check for Sources of Electrical and Optical Noise	86
10 Accessories	87
10.1 Cordsets	87
10.2 Brackets	87
10.3 Other Accessories	87
10.4 Universal (Input) Safety Modules	88
10.5 Safety Controllers	88
10.6 Interface Modules	88

10.7 Contactors	89
11 Product Support and Maintenance	90
11.1 Update the Firmware	90
11.2 Handling the Scanner	90
11.3 Cleaning the Screens	90
11.4 Replace Your Scanner	90
11.5 Repairs	91
11.6 Contact Us	91
11.7 Banner Engineering Corp Limited Warranty	91
12 Standards and Regulations	92
12.1 Applicable U.S. Standards	92
12.2 Applicable OSHA Regulations	92
12.3 International/European Standards	93
13 Glossary	94

1 About This Document

1.1 Important . . . Read This Before Proceeding!

It is the responsibility of the machine designer, controls engineer, machine builder, machine operator, and/or maintenance personnel or electrician to apply and maintain this device in full compliance with all applicable regulations and standards. The device can provide the required safeguarding function only if it is properly installed, properly operated, and properly maintained. This manual attempts to provide complete installation, operation, and maintenance instruction. *Reading the manual in its entirety is highly recommended.* Please direct any questions regarding the application or use of the device to Banner Engineering.

For more information regarding U.S. and international institutions that provide safeguarding application and safeguarding device performance standards, see [Standards and Regulations](#) on page 92.



WARNING: User Responsibility

The user is responsible to:

- Carefully read, understand, and comply with all instructions for this device.
- Perform a risk assessment that includes the specific machine guarding application. Guidance on a compliant methodology can be found in ISO 12100 or ANSI B11.0.
- Determine what safeguarding devices and methods are appropriate per the results of the risk assessment and implement per all applicable local, state, and national codes and regulations. See ISO 13849-1, ANSI B11.19, and/or other appropriate standards.
- Verify that the entire safeguarding system (including input devices, control systems, and output devices) is properly configured and installed, operational, and working as intended for the application.
- Periodically re-verify, as needed, that the entire safeguarding system is working as intended for the application.

Failure to follow any of these responsibilities may potentially create a dangerous condition that could result in serious injury or death.

1.2 Use of Warnings and Cautions

The precautions and statements used throughout this document are indicated by alert symbols and must be followed for the safe use of the SX5 Safety Laser Scanner. Failure to follow all precautions and alerts may result in unsafe use or operation. The following signal words and alert symbols are defined as follows:

Signal Word	Definition	Symbol
WARNING	Warnings refer to potentially hazardous situations which, if not avoided, could result in serious injury or death.	
CAUTION	Cautions refer to potentially hazardous situations which, if not avoided, could result in minor or moderate injury.	

These statements are intended to inform the machine designer and manufacturer, the end user, and maintenance personnel, how to avoid misapplication and effectively apply the SX5 Safety Laser Scanner to meet the various safeguarding application requirements. These individuals are responsible to read and abide by these statements.

1.3 EU Declaration of Conformity (DoC)

Banner Engineering Corp. herewith declares that the **SX5 Safety Laser Scanner** is in conformity with the provisions of the Machinery Directive 2006/42/EC and all essential health and safety requirements have been met.

Representative in EU: Peter Mertens, Managing Director Banner Engineering Europe. Address: Park Lane, Culliganlaan 2F, bus 3, 1831 Diegem, Belgium.

2 Product Overview

The SX5 Safety Laser Scanner is an electro-sensitive protective equipment (ESPE). It employs active opto-electronics productive devices responsive to the diffuse reflection of a radiation (AOPDDR), according to the definition and requirements of international safety standard IEC 61496-3. The optical radiation is a class 1 infrared laser generated within the device.

When the device is properly installed on a machine that presents a risk of personal injury, it provides protection by making the machine revert to a safe condition before a person reaches the hazardous points.

The working principle is that the invisible beam of the laser creates a two-dimensional safety area that must be crossed to reach the dangerous points. In this way the dangerous movement of the machine can be stopped before anyone reaches the hazard point.

The safety area can be horizontal or vertical and by using a Graphic User Interface, its shape can be planned according to the application needs.

The beam is emitted in short interval pulses and they are reflected by objects in the safety area. The device calculates the distance to the object by measuring the time interval between the transmission of the pulse and its reception after being reflected (time-of-flight principles).

The safety area is scanned by a mirror that deflects the light pulses over the 275° area around the device by rotating at a constant speed. In this way, all the opaque objects that have a certain dimension can be detected in the safety area.

Within the sensing range of the scanner, two areas can be monitored simultaneously: one is the Safety Zone, that is used to detect operators or objects entering a hazardous area; the other is the Warning Zone that can be defined with a longer distance than the Safety Zone, allowing a configuration to detect objects that are approaching the Safety Zone. Configurations can also be created with one Safety Zone and two different Warning Zones.

The scanner will only turn its Safety Outputs ON when the Safety Zone is free of obstructions, either automatically or following a manual restart (reset) signal, depending on the operating mode.

The scanner should be connected to a self-checking safety module, safety controller, or safety PLC/PES that has the ability to perform the external device monitoring (EDM) function. This function ensures the fault detection capability required by U.S. Control Reliability and ISO 13849-1 Category 3 or PL d for controlling final switching devices (FSDs) or Machine Primary Control Elements (MPCEs). The device that the scanner is connected to must perform to the level of performance required by the risk assessment.

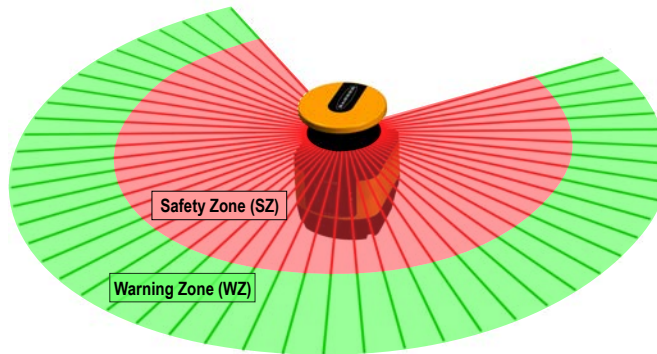

Figure 1. The maximum Safety Zone (5.5 m) and Warning Zone (40 m)

Key	Description	Distance
SZ	Maximum Safety Zone range	5.5 meters
WZ	Maximum Warning Zone range	40 meters

2.1 Models

A SX5 Safety Laser Scanner System refers to the laser scanner, cordsets (ordered separately), and mounting hardware (ordered separately). Interfacing solutions include safety modules, controllers, and muting modules.

Model	Description
SX5-B	SX5 Safety Laser Scanner, basic model

The following items, ordered separately from the scanner, are required to make a complete system.

Qty	Description
1	Mounting hardware (If desired, can mount directly to a surface)
1	Machine interface cable
1	M12 Ethernet cable



Important: Configuration software is required. The software is available at www.bannerengineering.com/SX5.

2.1.1 Features



Figure 2. Features of the SX5 Safety Laser Scanner

1. Display
2. LED indicators
3. M12 Ethernet connector cover
4. Keypad

2.1.2 Scanner Limitations

Environmental limitations — The SX5 Safety Laser Scanner is not suitable for use outdoors or under conditions with significant temperature fluctuations. Humidity, condensation, and other weather influences can impair the safety function.

- Use the SX5 only in environmentally controlled areas.
- Observe all technical data and ambient conditions.

For industrial use only — The SX5 can cause radio interference and is not suitable for use in residential areas. Only use the Scanner in industrial environments.

Not for use on vehicles with combustion engines — The SX5 is not suitable for use on vehicles with combustion engines, because alternators or ignition systems can cause EMC disturbances.

Make no modifications to the Scanner — The SX5 may not be modified, or the Protective function of the Scanner can no longer be guaranteed. Where changes are made to the Scanner, all guarantee claims against the manufacturer of the Scanner shall no longer apply.

Service life TM in accordance with DIN ISO 13849 — The SX5's PL and PFHd specifications refer to the TM service life of 20 years. Repairs or replacement of wear and tear parts do not extend the service life.

Protective function limits — The SX5 does not protect against (including, but not limited to):

- Parts that are ejected from a machine
- Splashing/spraying liquids
- Gases and vapors
- Radiation

Vapors, smoke, dust, particles — Vapors, smoke, dust and all particles visible in the air can cause the machine to switch OFF unintentionally. Do not use the SX5 in environments in which heavy vapors, smoke, dust or other visible particles are present.

Stray light limitations — Light sources (including infrared, fluorescent, and strobe lights) can impair reliability. Ensure that no interfering light sources are present within the SX5 detection plane.

- Prevent reflective surfaces at beam level.
- Where applicable, take additional separation (safety) distances into account.

- Ensure that there are no other photoelectric sources within the SX5 detection plane that can impair performance.

Monitoring through a window restriction — Do not use the SX5 to monitor an area (scan) through any window or transparent materials. Doing so can result in false detection that will cause nuisance machine stoppages.

2.1.3 Product Specification Label



Figure 3. Product Identification Plate

2.2 Documents List

The information for applying and configuring the SX5 Safety Laser Scanner is covered in several documents to simplify access to information. The current version of the configuration software program and all PDF documents can be downloaded from the Banner website www.bannerengineering.com.

Print out the relevant instructions to simplify reading and handling the documents.

Document Title	Document Content	Source
SX5 Safety Laser Scanner Datasheet	General product information and diagnostic reference	Included with the product in print and available for download (p/n 208910)
SX5soft	Configuration and diagnostic software	Download SX5soft from www.bannerengineering.com .
SX5 Safety Laser Scanner Instruction Manual	Operation capabilities, functions, and applications, for the machine designer, installer, and end user	Download document part number 208913
SX5 Safety Laser Scanner Checkout Procedures	Instructions for daily and semi-annual checkouts of Scanner installation	Download document part numbers 208911 (Semi-Annual) and 208912 (Daily). Print as needed and post near the guarded equipment.

2.3 Appropriate Applications and Limitations



WARNING: Read this Section Carefully Before Installing the System

If all mounting, installation, interfacing, and checkout procedures are not followed properly, the Banner device cannot provide the protection for which it was designed. The user is responsible for ensuring that all local, state, and national laws, rules, codes, or regulations relating to the installation and use of this control system in any particular application are satisfied. Ensure that all legal requirements have been met and that all technical installation and maintenance instructions contained in this manual are followed.

The user has the sole responsibility to ensure that this Banner device is installed and interfaced to the guarded machine by Qualified Persons¹, in accordance with this manual and applicable safety regulations. **Failure to follow these instructions could result in serious injury or death.**

The Banner SX5 is intended for safeguarding applications as determined by a risk assessment. It is the user's responsibility to verify whether the safeguarding is appropriate for the application and is installed, as instructed by this manual, by a Qualified Person.

The SX5's ability to perform its safeguarding function depends upon the appropriateness of the application and upon its proper mechanical and electrical installation and interfacing to the guarded machine. **If all mounting, installation, interfacing, and checkout procedures are not followed properly, the SX5 cannot provide the protection for which it was designed.**



WARNING:

- **Access and Perimeter Safeguard Installation**
- **Failure to follow these instructions could result in serious injury or death.**
- If an SX5 Safety Laser Scanner is installed for use as an access or perimeter guard (where a pass-through hazard may exist, see [Reducing or Eliminating Pass-Through Hazards](#) on page 31), configure the SX5 for Manual Start/Restart (Latch Output). The dangerous machine motion can be initiated by normal means only after the safeguarded area is clear of individuals and the SX5 Safety Laser Scanner has been manually reset.

2.3.1 Appropriate Applications

The user has the sole responsibility to ensure that the SX5 Safety Laser Scanner is appropriate for the application and is installed and interfaced by Qualified Persons in accordance with this manual and applicable safety regulations.

The SX5 Safety Laser Scanner must be integrated into the machine's control system in such a way that an activation of the safety function safely stops or interrupts the dangerous process before a person can be endangered.

This SX5 Safety Laser Scanner is typically used in access guarding and perimeter guarding applications. Some potential applications are:

- Automated production equipment
- Robotic work cells
- Assembly and packaging machines
- Lean manufacturing systems
- Safety mat replacements

Do not use the SX5 Safety Laser Scanner:

- With any machine that can not be stopped immediately after a stop signal is issued, such as single-stroke (full revolution) clutched machinery
- With any machine with inadequate or inconsistent machine response time and stopping performance
- With any machine that ejects materials or component parts through the safety zone
- In any environment that is likely to adversely affect photoelectric sensing efficiency. For example, corrosive chemicals or fluids or severe levels of smoke or dust, if not controlled, may degrade sensing efficiency
- As a tripping device to initiate or reinitiate machine motion (PSDI applications), unless the machine and its control system fully comply with the relevant standard or regulation (see OSHA 29CFR1910.217, ANSI/NFPA 79, ANSI B11.19, ISO 12100, IEC 60204-1, IEC 61496-1, or other appropriate standard)



WARNING:

- Proper Use
- Failure to follow all instructions and warnings could lead to serious bodily injury or death.
- Only use the SX5 Safety Laser Scanner on machinery that can be stopped immediately after a stop signal is issued at any point in the machine's stroke or cycle. Under no circumstances may the Scanner be used on full-revolution clutched machinery or in unsuitable applications as those listed.
- Allow only Qualified Persons to install and maintain the SX5 Safety Laser Scanner. Perform the Shift/Daily checkout procedure at every power-up, shift change, and machine setup. Refer to the instruction manuals and other reference materials (located in the Help menu) for all installation details, wiring diagrams, operating instructions, shift/daily/periodic checkout procedures, and warnings.
- If there is any doubt about whether or not your machinery is compatible with the SX5 Safety Laser Scanner, contact Banner's Application Engineers.

¹ A person who, by possession of a recognized degree or certificate of professional training, or who, by extensive knowledge, training and experience, has successfully demonstrated the ability to solve problems relating to the subject matter and work.

2.3.2 Control Reliability: Redundancy and Self-Checking

Redundancy requires that the SX5 Safety Laser Scanner circuit components be backed up to the extent that, if the failure of a single component will prevent effective machine stopping action when needed, that component must have a redundant counterpart which will perform the same function. The SX5 Safety Laser Scanner is designed with redundant microprocessors.

Maintain redundancy whenever the SX5 Safety Laser Scanner is in operation. Because a redundant system is no longer redundant after a component has failed, the SX5 Safety Laser Scanner is designed to monitor itself continuously. A component failure detected by or within the self-checking system sends a stop signal to the guarded machine and puts the SX5 Safety Laser Scanner into a Lockout condition.

A recovery from this type of Lockout condition requires:

- Replacing the failed device (to restore redundancy, only performed by Banner Engineering Corp.)
- Performing the appropriate reset procedure

Use the Diagnostic Display to diagnose causes of a lockout condition. See [Troubleshooting](#) on page 82.

2.3.3 Application Checklist

The SX5 Safety Laser Scanner can provide a protective function only when its settings and connections (software configuration, Safety and Warning Zone dimensions, electrical interfacing, mounting, environmental conditions, supplemental safeguarding, etc.) are coordinated with its application. The checklist items below and the following application examples are intended to give additional guidance in applying the SX5 Safety Laser Scanner.

The following items are provided to assist in creating a checklist or to be included in a risk assessment for the application of the SX5. Additional items may be required, depending on the application.

- Review this instruction manual
- Identify the appropriate application (required resolution, field orientation, etc):
 - Expert for horizontal applications
 - Vertical for vertical applications
- Determine the area to be safeguarded and the SX5's installation location and means.
- Determine whether the SX5 requires protection from mechanical damage.
- Ensure that the environmental conditions do not exceed the SX5 specifications.
- Determine the size and coverage of the Safety Zone and Warning Zone (if used) depending on:
 - Physical location of the SX5 installation,
 - The minimum safety distance or the stopping distance of the mobile vehicle
 - The height (H) of the Protective Field (horizontal applications)
 - Other factors that may require an increased minimum safety distance (e.g. "shadowing", adjacent SX5, retro-reflective surfaces, brake performance degradation)
-  **Important:** It is recommended to visibly mark the Protective/Warning Field boundaries, if possible.
- Assess the possibility of avoiding detection by the SX5 by climbing/stepping over, crawling under, moving around the protection field(s), either at the perimeter of the fields or in unprotected areas caused by the shadow effect.
- Determine whether additional/supplement safeguarding is required.
- Determine the proper startup, start/restart (manual/automatic reset), and other safety-relevant parameters. If the manual restart is used, determine the position for the reset button.
- Determine whether Zone Set switchover is required and identify the conditions for its use.
- Determine whether the Reference Point function is required (at least three (3) reference points must be defined on fixed surface(s)).
- Determine the method and means of electrical interfacing dependent on the level of risk determined by the risk assessment (e.g., OSHA/ANSI control reliability or ISO 13849-1 category 3 PLd).

2.3.4 Sample Applications

The SX5 Safety Laser Scanner is used to detect people who are approaching a hazardous area, before reaching it, to prevent hazardous circumstance (i.e. mechanical movement) that may cause an accident.

The protective detection is done by defining a safety area (the red zone in the figures), whose shape and dimensions must be designed according to the risk assessment of the machine. The user must consider the position of the hazardous points, the shape of the machine and of the environment that surrounds it, and the time needed to stop the dangerous movement.

To better ensure people's safety, it is possible to define a warning area (the green zone in the figures): if a person or an object is approaching too close to the safety area, the safety laser scanner can trigger warning devices. This warning area cannot be used for safety purposes.

The following application examples should be considered just as references for instructional purposes.

Stationary Area Guarding (Horizontal Danger Zone Guarding)

Area Guarding uses a horizontal sensing field (i.e., Safety or Warning Zones) to continually sense an individual within a safeguarded area. Area Guarding can reduce or eliminate the possibility of a pass-through hazard that could result in an individual being exposed to unexpected machine startup or motion.

As an individual approaches, the Warning Zone (the green area) can illuminate a warning beacon or sound an alarm that the Safety Zone (the red area) is about to be entered. In conjunction with markings on the floor, the use of a Warning Zone can eliminate intermittent stopping due to individuals being unaware of the safeguarded area. When the Safety Zone is encroached upon, a stop is issued and the hazard is brought to a safe state.

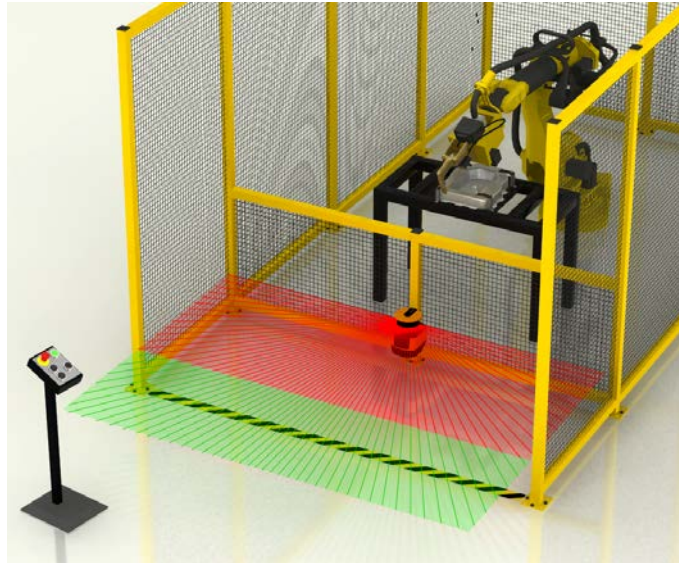

Figure 4. Horizontal stationary area guarding

Typical considerations for horizontal stationary area guarding:

- In this example, the SX5 is mounted in the center of the operator work station to maximize the available size of the Safety and Warning Zones. The SX5 is mounted directly to the cell's perimeter guarding fencing 300 mm above the floor to prevent crawling under the Safety Zone.
- In this example, physical damage is not expected because the fencing provides adequate protection. If interference with the operator is expected, the Scanner can be recessed into the fencing to minimize exposure.
- The typical manufacturing setting is well within the SX5's environmental ratings.
- The size and coverage of the Safety Zone must ensure that the hazard cannot be accessed by moving (reaching) around, under, or over the Safety Zone. Access to the hazard is prevented by the fencing along the side of the Safety Zone, which minimizes the required floor space.
- For this example, assume a robot stopping time of 100 ms, SX5 response time of 62 ms, the response time of a safety interfacing device is 25 ms (UM-FA-9A safety module). Because an individual can reach over the detection plane by bending at the waist, the D_{pf} adder is equal to 1200 mm (U.S. formula) and the Measurement Tolerance Factor (Z_{SM}) must be accounted for. This gives a safety distance of: $D_s = 1600 \text{ mm/s} \times (0.1\text{s} + 0.062\text{s} + 0.025\text{s}) + 1200 \text{ mm} + 150 \text{ mm} = 1649 \text{ mm} (64.9 \text{ in})$. In other words, the leading (outside) edge of the Safety Zone must be 1649 mm from the nearest hazard.
- It is recommended to mark the boundary of the Safety/Warning Zone on the floor.
- This example has no factors that would require an increase in the safety distance.
- There is no possibility of easily stepping, climbing or otherwise avoiding detection.
- Because there is no pass-through hazard, the SX5 can be configured for "automatic start/restart (reset)". However, the machine control circuitry must be designed so that one or more initiation devices must be engaged (e.g. a conscious act is required) to start the machine.
- Further, any initiation devices (or reset switches) must comply with the Reset Switch Location.
- For the purpose of this example, the UM-FA-9A Universal Input Safety Module was used and interfaced in a control reliable (category 3 or 4) method as described in the wiring diagram.

Stationary Area Guarding with Zone Set Switchover

An Area Guarding application can use the Zone Set Switchover function to automatically allow access to one area while simultaneously guarding another hazardous area. This can improve machine cycle efficiency by allowing the operator to remove/place parts while the operation is in a different area, for example.

The robot position (i.e., the location of the hazard) is monitored to identify when no hazard exists at one work station, at which time the Zone Sets are switched. The Zone Set Switchover function is much like a muting application for a safety light screen.

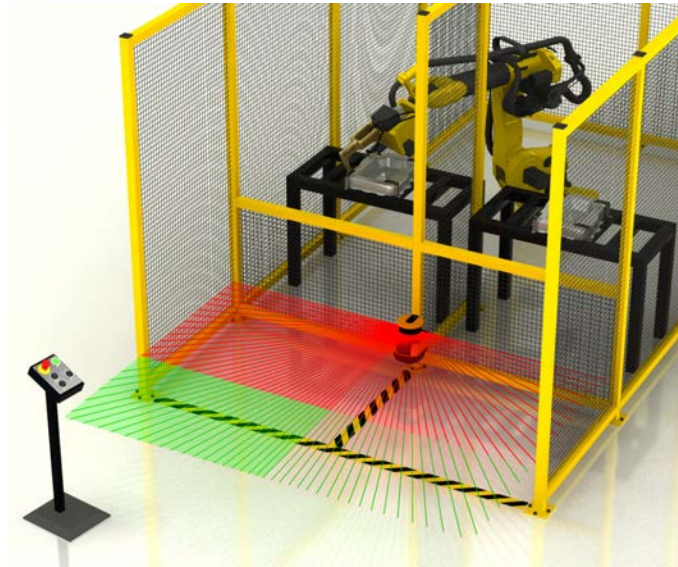

Figure 5. Sample application with Zone Set Switchover

In addition to the typical considerations for horizontal stationary area guarding, for this example:

- Ensure that no individual is exposed to a hazard while employing the Zone Set switching function. The risk assessment should determine the applicability of this function, means of selecting Zone Sets in respect to failure modes, and whether supplemental safeguarding is required.
- In higher risk applications that require control reliability (category 3 or 4) interfacing, it is highly recommended to use redundant sensors or switches to initiate or enable a Zone Set change.
- If two Zone Sets are used the Warning Auxiliary output can be used in conjunction with the Warning Zones. If three Safety Zones are desired (right, left, entire area) then the Warning output pin is required for selecting the Zone Set (Safety Zone).

Stationary Area Guarding with Multiple Scanners

Area Guarding is frequently used in conjunction with other safeguards, such as interlocked gates on fencing or vertically positioned safety light screens/grids (for example, perimeter guarding). The purpose of the safeguarding located at the perimeter of the work cell is primarily to detect entry into the hazardous area, while the area guarding (for example, the SX5) is responsible for preventing machine restart or other machine hazards while the individual remains within the work cell.

In such applications, it is important not to have any voids or unmonitored areas (dead spaces) in the detection capability of the Area Guarding system. The SX5 can be configured for irregularly shaped protection fields to accomplish this.



Important: Area Guarding and Perimeter Guarding should not be used in place of Lockout/Tagout procedures.

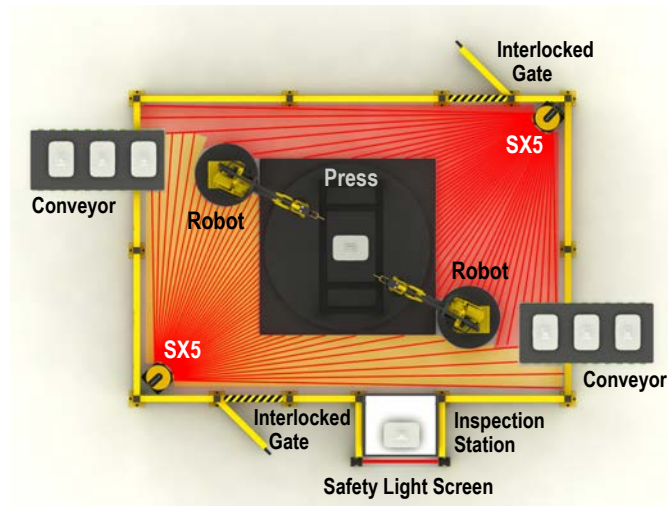

Figure 6. Stationary area guarding with multiple scanners

In addition to the typical considerations for horizontal stationary area guarding listed in example #1:

- Install multiple SX5 with a vertical offset height of 100 mm (or more) or use physical shielding to prevent one SX5 from interfering with another SX5.
- Be aware of the effect of needle- and cone-shaped fields and eliminate areas of unreliable detection.
- Eliminate the "shadow effect" and/or use additional safeguarding.
- Configure the SX5 for start/restart interlock (manual reset) to ensure that the Scanner does not turn ON its safety outputs if an individual is momentarily undetected (e.g., climbs up onto the machinery above the plane of the Protective Field).
- Configure any perimeter guarding systems (e.g., an interlocked gate or safety light screen) for a manual reset; any reset switches must comply with the Reset Switch Location Section.

Mobile Area Guarding on Transfer Carts/Trolleys and Automated Guided Vehicles (AGVs)

On mobile applications, such as transfer carts, the SX5 monitors the area directly ahead of the cart using both the Warning and the Safety Zones. If something is detected within the Warning Zone (the green area), the alarm output signals the vehicle logic to slow the vehicle and sound a horn (or other awareness device). The SX5 stops the vehicle when something is detected within the Safety Zone (the red area). If the speed increases or decreases, alternate Zone Sets can be used to adjust for varying stopping distances.

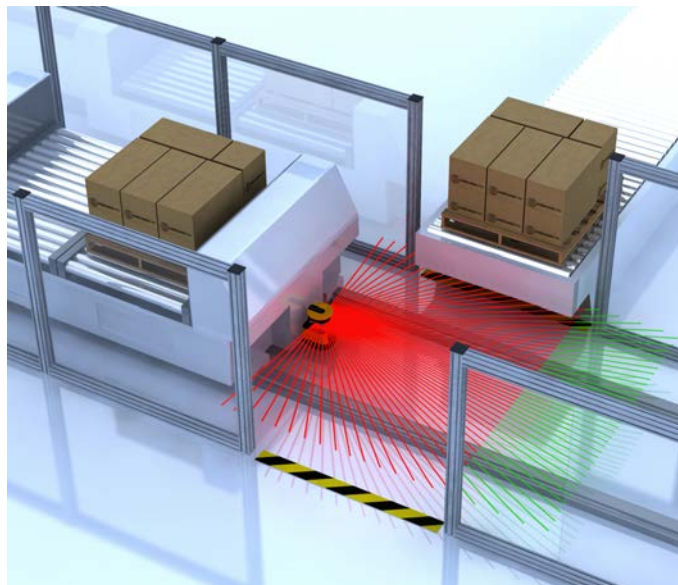

Figure 7. Mobile area guarding on AGVs

Typical considerations for mobile vehicle guarding (horizontal fields):

- In this example, the mobile vehicle is a transfer cart that travels in two directions along a pair of rails. Each direction of travel is guarded by separate, individually configured Scanners on either end of the vehicle, mounted 150 mm (5.9 inch) above the plane of the floor (not the rails). The plane of the Safety Zone should not exceed 200 mm (7.9 in) above the floor.
- In this example, physical damage is not expected because the path of travel is restricted.
- The typical manufacturing setting is well within the SX5's environmental ratings.
- Safety Zone Length (Minimum Distance D): For this example, assume a maximum vehicle speed of 1200 mm/s (48 in/s), a breaking distance of 900 mm (35 in), SX5 response time of 122 ms (4 scans), the response time of a vehicle drive and safety interfacing 100 ms, which results in an overall stopping distance of 1166 mm (46 in). $D_{SD} = [1200 \text{ mm/s} \times (0.1 \text{ s} + 0.122 \text{ s})] + 900 \text{ mm}$. This value is added to the Additional Distance Factors (Z) to determine the Safety Zone length, which for this example are:
 - $Z_{SM} = 150 \text{ mm}$ (5.9 in)
 - $Z_{refl} = 0$ — The possibility of retro-reflectors located within the scanning plane of the Protective Field can be excluded.
 - $Z_F = 100 \text{ mm}$ (4 in) — To the ground clearance of the transfer cart's sides is 60 mm (2.4") and the wheels are not accessible.
 - $Z_A = 500 \text{ mm}$ (20 in) — The possibility of crushing/trapping hazard against the overhanging conveyor and the transfer cart is an application specific addition for this example.
 - The total Safety Zone length (Minimum Distance) from the SX5 to the leading edge of the Safety Zone is 1916 mm (75.4 in).
- Safety Zone Width (Additional Side Distance Z): The Z factors to determine the Safety Zone width are primarily the same as above ($Z_{SM} = 150 \text{ mm}$, $Z_{refl} = 0$, $Z_F = 100 \text{ mm}$), but the application specific adder, $Z_{A(SIDE)}$, is now used to account for the entire area to the sides the cart and under the overhang of the conveyor. This distance is 300 mm (12 in); $Z_{SM} + Z_F = 250 \text{ mm}$ (9.8 in), thus Z_A must equal 50 mm (2 in) to ensure the entire area to the sides of the cart are monitored. The total width of the Safety Zone for this example is 1666 mm (66 in), which is the width of cart of 1066 mm (42 in) plus the value of the two 300 mm side distances.
- A 190° Safety/Warning Zone should be used to minimize any unmonitored area at the SX5's sides.
- The vehicle's maximum speed should be identified in the SX5's configuration. In this example the maximum speed is 1200 mm/s.
- The Warning Zone is used to slow the transfer cart and sound a horn if an object is detected.
- The design of the transfer cart ensures that there are no protruding loads (e.g., pallets) that could become a hazard.
- The fencing (supplemental safeguarding) along the path of the transfer cart reduces the risk of an individual stepping directly in front of the cart; this allows the Safety Zone width to be minimized. The fencing also reduces, but does not eliminate, the possibility of crushing/trapping hazards between the transfer cart and the conveyor because the individual is detected by the leading edge of the Safety Zone.
- In this example, the movement of the transfer cart is controlled primarily by on-board logic that is safety-rated. This allows the movement to begin after the material control system (conveyor logic) commands the cart to a specific location. Automatic restart function must incorporate a two-second delay after the Safety Zone becomes clear (per BS/DIN EN 1525).

The on-board logic of the transfer cart that controls beginning and stopping motion and the means of electrical interfacing must be evaluated during the risk assessment to meet the required level of safety performance (e.g., control reliability or category 3 or 4).

Vertical Guarding with Reference Point Monitoring

This example application uses two SX5s with Safety Zone Switchover to safeguard a pallet load/unload station. The two Safety Zones per SX5 are enabled (the red lines) and disabled (pink shaded areas) as pallets are loaded/unloaded and as they enter/exit the work cell at the rear of the station.

The SX5's Area Switch inputs identify the position of a pallet to determine which Safety Zone to disable. The Reference Points (blue points) ensure that the Safety Zones are in the proper position.

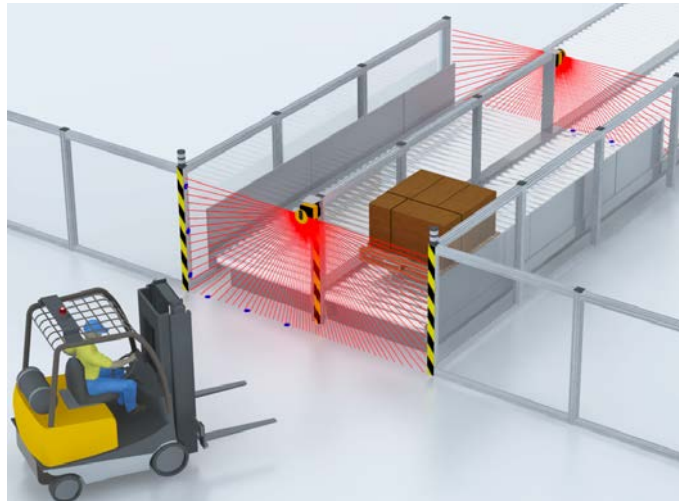

Figure 8. Vertical guarding with reference contour monitoring

Typical considerations for vertical guarding:

- In the example shown, the objective is to prevent an individual from entering an area; detecting the body (torso) is required.
- In this example, physical damage is not expected because the SX5 is mounted above and away from the probable path of the forklift. If impact is possible, a mechanical guard/shroud can be added to protect the SX5 without blocking the Safety Zones.
- The typical manufacturing setting is well within the SX5's environmental ratings.
- The size and coverage of the Safety Zone must ensure that unrestricted or accidental entry to the work cell is prevented. Two SX5s are used to create four Safety Zones to cover each end of the pallet load/unload station (e.g. left side SZ, right side SZ, and both sides SZ). When no pallets are at the station, the front SX5 has a Safety Zone that covers both sides; the rear SX5 can be muted to allow pallets to be fed into the station (such as pallets exiting the cell). As pallets are loaded, sensors monitoring the pallet position switch the Zone Sets to "turn off" the front Scanner's right side and "turn on" (and unmute) the rear SX5's Safety Zone for that side (as shown). This allows the forklift to pick up the pallet and remove it.
- When the front Safety Zone is inactive, the pallet must completely block the opening to prevent access. When the pallet is removed, that Safety Zone must immediately be re-activated.
- The use of the Reference Points is required for vertical guarding applications (e.g. the blue points).
- In this example, no factors would require an increase in the safety distance.
- For this example, assume a machine stopping time of 200 ms, SX5 response time of 62 ms; safety interfacing device (UM-FA-9A safety module) response time is 25 ms. The resolution can be either 40 or 70 mm, since only body detection 70mm can be selected, the D_{pf} adder is equal to 900 mm (U.S. formula). This gives a safety distance of: $D_s = 1600 \text{ mm/s} \times (0.2\text{s} + 0.062\text{s} + 0.025\text{s}) + 900 \text{ mm} = 1359 \text{ mm} (53.5 \text{ in})$. In other words, the plane of the rear Protective Field must be no closer than 1359 mm (53.5 in) from the nearest hazard (assuming no hazard inside the load station).
- Configure the SX5 for start/restart interlock (manual reset) to ensure that if an individual interrupts an active Safety Zone while attempting to enter the guarded area that the SX5's OSSD safety outputs remain OFF until manually reset after the individual exits the cell.
- For the purpose of this example, the UM-FA-9A Universal Input Safety Module was used and interfaced in a control reliable (category 3 or 4) method as described by Section 3 and Figure 3-19.

Mobile Area Guarding with Side Vertical Guarding

Vertically guarding the sides of transfer carts, material-handling trolleys, and Automated Guided Vehicles (AGVs) prevents contact with objects that may have overrun the stop position of a conveyor, which could result in damage to the mobile vehicle and the conveyor. This type of guarding can also be used for situations that with a crushing/trapping hazard, for example, a distance less than 500 mm (20 in) between the sides of the SX5 and a physical structure.

Two SX5s are positioned to create horizontal Safety Zones, to prevent running over objects or individuals in the path of the vehicle. A second pair of vertically mounted SX5s is positioned to detect objects at or above the horizontal plane of the SX5s that are looking ahead of, and behind the vehicle. In this configuration, the "leading edge" of the Safety Zone is now provided by the vertical edges on the sides of the SX5. These edges will detect the torso of an individual; 70 mm resolution is typically selected.

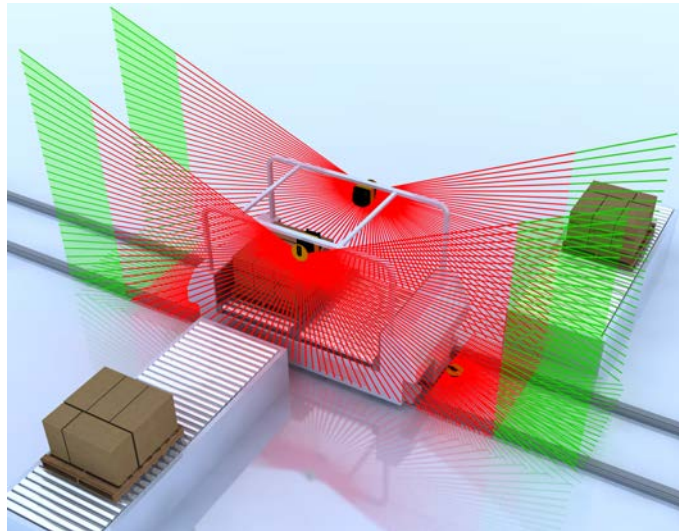

Figure 9. Mobile area guarding with side vertical guarding

In addition to the typical considerations for mobile area guarding (see [Mobile Area Guarding on Transfer Carts/Trolleys and Automated Guided Vehicles \(AGVs\)](#) on page 13):

- Select 70 mm resolution for torso detection.
- Set the leading edge of the vertical Safety Zone no shorter (smaller) than the corresponding horizontal Safety Zone (assuming that the response times and safety distances are equal).
- Position the vertical Safety Zones at a slight angle so that the lower Safety Zone edges protrude over the vehicle width by the amount of the additional distances Z_{SM} , Z_F , Z_{REFL} and Z_A when required (see [Vertical Guarding with Reference Point Monitoring](#) on page 14).
- The configuration of reference points, as with other vertical guarding applications, is not required, because the approach of the individual is detected by the edge of the Safety Zone and not the plane. As with the horizontal Safety Zones, the vertical Safety Zone must be checked (verified) on a periodic basis.
- Minimize crushing/trapping hazards by using supplemental safeguarding, such as by preventing access (e.g., fencing) or by causing the individual to be detected by the leading edge of the horizontal Safety Zone.

2.4 Operating Features

The Banner SX5 Safety Laser Scanner models described in this instruction manual feature several functions. Configuring some of these functions must be accomplished by a Qualified Person to ensure that personnel who are exposed to potentially dangerous situations are adequately protected. Features include:

- Selecting automatic or manual start/restart
- Configuring the response time
- Setting the Warning and Safety Zones
- Defining a Warning output
- Configuring a muting evolution

For more information, see [Configuration Instructions](#) on page 53.

2.5 Reference Points (Surface) Monitoring

The reference points (surface) monitoring function prevents unintentional misalignment and deliberate manipulation of the SX5.

If the configuration contains reference points, the SX5 monitors both the Safety Zone (for intrusions) and the reference points (for position). If the distance between the scanner and the reference surface (point) changes from the configuration (greater than the assigned tolerance), the SX5 detects the change and switches the OSSDs to OFF.

The design of the installation and the risk assessment must identify the need and use of the reference points (surface) monitoring function. In horizontal applications, this function ensures that the safeguarded area does not change due to the SX5 moving or changing position because of an impact, vibration, or poor maintenance practices. In a vertical application, the position of the Safety Zone has a critical effect on the separation (safety) distance. If there is an angular movement of the SX5 that causes the Safety Zone to be positioned closer to the hazard, an individual could access the hazard before the machine can stop.

With a vertical Safety Zone (angle of approach greater than $\pm 30^\circ$), it is required that at least three (3) reference points be assigned. The reference points must be assigned on a surface that will be present but do not have to be at the edge of the Safety Zone. The surface must be within 5500 mm (for 70 mm resolution) or 3000 mm (for 40 mm resolution) range of the scanner. The reference points should be on at least two sides, areas, or surfaces.

For more information on how to create a Safety Zone and use reference points, see [Safety Zone Area - Length and Width](#) on page 34.



Note:

- **Reference Points**
- Failure to follow these recommendations can potentially create a dangerous situation that may lead to serious injury or death.
- The design of the installation and the risk assessment must identify the need and use of the reference points (surface) monitoring function. A change in the position or mounting of the SX5 can result in gaps/unmonitored areas and an incorrect (too small) safety distance (minimum distance). It is recommended that Reference Point Monitoring be used for all stationary applications that have surfaces that can be monitored.

2.6 Passwords

Improperly set parameters on the SX5 can cause serious accidents. The configuration of the SX5 is therefore protected by passwords.

SX5soft is not password protected. Users can create and save (to the PC) a configuration file without entering a password. A password is required to upload a configuration to a SX5.

Ensure that the passwords are secured by the Qualified Person. The default password is `admin`. Call Banner Engineering technical support if a password is unknown.

The people responsible for the machine's safety must ensure that the appropriately Qualified Person can properly perform the tests and work on the machine and the SX5 in accordance with their intended use.

2.7 Laser Safety (Class 1)

The SX5 Safety Laser Scanner has a Class 1 laser.



Figure 10. Laser safety label

2.7.1 Class 1 Lasers

Class 1 lasers are lasers that are safe under reasonably foreseeable conditions of operation, including the use of optical instruments for intrabeam viewing.

Reference IEC 60825-1:2014, Section 8.2.



Figure 11. Class 1 laser characteristics

2.7.2 For Safe Laser Use (Class 1 or Class 2):

- Do not stare at the laser.
- Do not point the laser at a person's eye.
- Mount open laser beam paths either above or below eye level, where practical.
- Terminate the beam emitted by the laser product at the end of its useful path.



CAUTION:

- **Never stare directly into the sensor lens.**
- Laser light can damage your eyes.
- Avoid placing any mirror-like object in the beam. Never use a mirror as a retroreflective target.

2.8 Software Overview

Use SX5soft to establish operational settings for the SX5 and to display measurement and system information produced by the SX5. Communication between the PC and the SX5 is via an Ethernet network.

The SX5 is preprogrammed at the factory with a default configuration but must be reconfigured for each application. The factory default configuration sets the Warning and Safety Zones to their maximum limits.

The configuration settings are created by a trained and Qualified Person who understands the SX5 instruction materials. These settings are saved in an .xml configuration file and includes all the information that the SX5 requires for its intended operation. An SX5's configuration file includes the following data:

- Administrative data, for example file name, application description
- Safety-relevant data, such as the startup process
- Safety Zone or Warning Zone configuration data, for example contours and limits

The menu progression in the program assists the user with the configuration process.

2.8.1 System Requirements

To use the system, the personal computer must meet the following minimum requirements:

Component	Recommended	Minimum
Processor(s)	Pentium 4	Pentium 4
Clock frequency	≥ 3 GHz	≥ 2 GHz
RAM	2 GB	1 GB
Free hard drive space	70 MB	70 MB
Monitor resolution	1280 × 768	1024 × 768
Supported operating systems	Windows 7, Windows 8, Windows 10	

The PC must also be equipped with the following hardware and software drivers:

- Installed Ethernet network card and installed driver
- One free 100 Mbps Ethernet port

2.8.2 Safety and Warning Zones

The software makes it easy to establish Safety and Warning Zones. The Safety Zone and the Warning Zone are user-defined areas that the Scanner monitors. An intrusion into the Safety Zone (such as a person walking into a monitored work cell) causes the SX5 to turn its safety outputs off. An intrusion into the Warning Zone causes the SX5 to create a warning signal.

Safety Zone and Warning Zone settings are created and saved as zone sets. Up to 6 configurable zone sets are available for the SX5. Zone sets can be enabled or disabled, one set at a time, while the SX5 is operational and actively monitoring a work area. This function is useful when changing machine guarding requirements create the need for changes in Safety Zone and Warning Zone dimensions.

2.8.3 Monitored Space Display

When the SX5 is actively monitoring an area, it measures the distance to, and the angular position of, objects in the area. These measurement data are transferred via an Ethernet connection to the PC when the Monitoring function is selected. The software uses this data to constantly update the display to show the Safety Zone and Warning Zone along with the measured surfaces of the monitored area.



Figure 12. Monitored space as shown by the SX5soft software

2.9 Security Protocol

Certain procedures for installing, maintaining, and operating the SX5 must be performed by either Designated Persons or Qualified Persons.

A **Designated Person** is identified and designated in writing, by the employer, as being appropriately trained and qualified to perform system resets and the specified checkout procedures on the SX5. The Designated Person is empowered to:

- Perform manual resets and hold possession of the reset key
- Perform the Daily Checkout Procedure

A **Qualified Person**, by possession of a recognized degree or certificate of professional training, or by extensive knowledge, training, and experience, has successfully demonstrated the ability to solve problems relating to the installation of the SX5 System and its integration with the guarded machine. In addition to everything for which the Designated Person is empowered, the Qualified Person is empowered to:

- Install the SX5 System
- Perform all checkout procedures
- Make changes to the internal configuration settings
- Reset the System following a Lockout condition

2.10 General Safety Information

- The machine stopping system must be electrically controlled.
- This control system must be capable of stopping the dangerous movement of the machine within the total machine stopping time (T_s) and during all the machine cycle phases.

- The device mounting and connections, must be carried out by qualified personnel only, according to the instructions included in the mechanical installation and electrical connection sections of this manual and applicable standards.
- The safety laser scanner must be securely placed in a particular position so that access to the dangerous zone is not possible without passing through the Safety Zone of the scanner.
- The personnel operating in the dangerous area must be well training and must have adequate knowledge of all the operating procedures of the machine and safety laser scanner.
- In cases of Manual Restart, the reset button must be located outside the safety area, see the reset switch location section of this manual.
- The requirements for electrical safety and electromagnetic compatibility and the regulations or standards in all countries and/or regions, must be met by the power supply where the laser scanner is used. If the device power supply is shared with the machine or other electronic devices, voltage fluctuations to the laser scanner or noise influences to the scanner may occur due to temporary changes of the current consumption on the machine or the other electronic devices. We do not recommend sharing the laser scanner power supply with the one for the machine or the other electronic devices, because the device may go to an error state in such circumstances.
- Do not run the connection cables in contact with or near high-voltage cables and/or cables which undergo large current variations (i.e. motor power supplies, inverters, etc.).
- Access to the configuration tools must be restricted to only highly qualified personnel. The configuration upload process through the GUI is allowed only by password.

2.11 Specifications

2.11.1 Specifications

Power Consumption

No output load: 8 W at 24 V dc
 With maximum output load: 27 W at 24 V dc
 Power-up delay: 40 seconds, typical

Current Consumption (24 V dc)

No output load: 0.3 A at 24 V dc
 With maximum output load: 1.1 A at 24 V dc

Power and Electrical Protection

Protection class: III (EN 61140 / IEC 61140)
 Supply voltage: U_v 24 Vdc (19.2 V ... 30 Vdc) (SELV/PELV)²
 Residual ripple: \pm 5%³
 Start-up current (I): < 0.6 A⁴
 The Scanner should be connected only to a SELV (Safety Extra-Low Voltage) for circuits without earth ground or a PELV (Protected Extra-Low Voltage) for circuits with earth ground power supply.

Light Beam Diameter

At front screen: 8 mm
 At middle field distance: 10 mm
 At max distance: 20 mm
 Detectable remission: 1.8% to 1000%
 Maximum homogeneous contamination of the optics cover without preventing the detection capability –30% of nominal optic power

Output (warning and generic)

Output logic and protection: PUSH-PULL, Overcurrent protection
 Output voltage for ON status (HIGH): U_v –2 V at 250 mA
 Output voltage for OFF status (LOW): 0 V
 Output current for ON status (HIGH): 250 mA
 Leakage current: < 700 μ A⁵
 Load inductance: 2 H
 Load capacity: 2.2 μ F

Static Input Generic

Input voltage high: > 12 V
 Input voltage low: < 5 V
 Input current high: 2 mA at 24 V dc
 Input impedance: 12 k Ω

Connectors

I/O and power: M12 male type A connector (8 poles)
 Ethernet to GUI or Data transmission: M12 male type D connector (4 poles)

Optical Data

Wavelength: 905 nm
 Pulse duration: 3 nsec
 Average output power: 8 mW
 Laser class: CLASS 1 (EN 60825-1)
 Divergence of collimated beam: 0.12°

Mechanical Data

Dimensions (W x H x D): 102 x 152 x 112.5
 Weight (including system plug): 1.5 kg
 Housing material: Aluminum Alloy
 Housing color: Yellow RAL1003
 Optics cover material: PC
 Optics cover surface: Acrylic

OSSD (Safety Output)

OSSD logic and protection: PUSH-PULL, Overcurrent protection
 Output voltage for ON status (HIGH): U_v –2V at 250 mA
 Output voltage for OFF status (LOW): 0 V
 Output current for ON status (HIGH): 250 mA
 Leakage current: < 700 μ A⁶
 Max Load inductance: 2 H
 Max Load capacity: 2.2 μ F
 Test pulse width: 300 μ s
 Test pulse interval: 167 ms
 OFF status duration: 900 ms
 Latency time between output pair: 450 ms

² To meet the requirements of the relevant product standards (e.g. EN 61496-1), the external voltage supply for the devices (SELV) must be able to bridge a brief mains failure of 20 ms. Power supplies according to EN 60204-1 satisfy this requirement.

³ The absolute voltage level must not drop below the specified minimum voltage.

⁴ The load currents for the input capacitors are not taken into account.

⁵ In the case of a fault (0 V cable open circuit) maximally the leakage current flows in the OSSD cable. The downstream controller must detect this status as LOW. A FPLC (fail-safe programmable logic controller) must be able to identify this status.

⁶ In the case of a fault (0 V cable open circuit) maximally the leakage current flows in the OSSD cable. The downstream controller must detect this status as LOW. A FPLC (fail-safe programmable logic controller) must be able to identify this status.

Safety Data

Type 3 (EN 61496-1)
 SIL 2 (IEC 61508)
 Category 3 (EN ISO 13849-1)
 SILCL 2 (EN 62061)
 PL d (EN ISO 13849-1)
 PFHd (mean probability of a dangerous failure per hour): 6.38×10^{-8}
 SFF: 97.58%
 MTTFd: 61 Years
 TM (mission time): 20 years (EN ISO 13849-1)
 HFT (Hardware Fault Tolerance): 1
 State of safety: OSSD in OFF State (open circuit → I OSSD = 0)
 Response time to malfunction: ≤ Response Time

Operating Conditions

0 °C to +50 °C (+32 °F to +122 °F)⁷
 95% maximum relative humidity (non-condensing) (According to IEC 61496-1 5.4.2; IEC 61496-3 5.4.2; 4.3.1; 5.4.4.3)

Storage Conditions

-20 °C to +70 °C (-4 °F to +158 °F)

Environmental Rating

IEC IP65

Features

Safety protective field range: 3 m, 5.5 m
 Warning field range: 40 m with remission of target = 90% (white)
 Scanning angle: 275°
 Detection capability: 40 mm, 70 mm
 Scan cycle time: 30 ms
 Response time: Programmable 62 to 482 ms
 Tolerance zone max: 150 mm
 Angular resolution: 0.1°
 Zones sets: 6 Max

Vibration

According to IEC 61496-1 4.3.3.1 ; 5.4.4.1 ; IEC 60068-2-6
 Frequency from 10 Hz to 55 Hz ; Scan Speed 1 octave/min
 Range: 0.35 mm ± 0.05 mm

Shock

According to IEC 61496-1 4.3.3.2 ; 5.4.4.2
 IEC 60068-2-29; Acceleration: 10 g; Pulse Duration: 16 ms; Number of Shocks: 1000 ± 10 (for each of the three mutually perpendicular axes)
 IEC 61496-3 5.4.4.1-3 ; IEC 60068-2-75 ; Hammer test

2.11.2 Dimensions

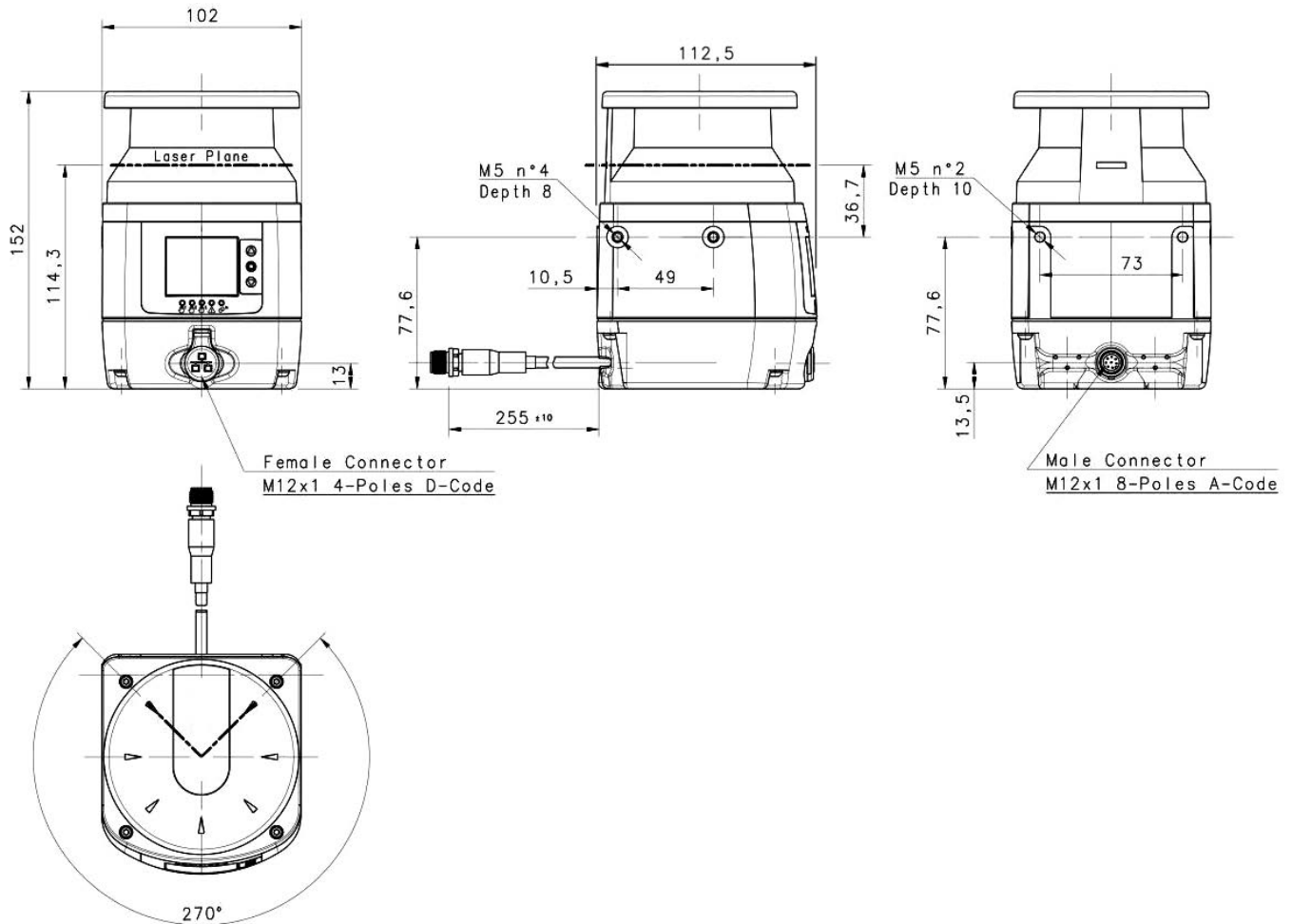

⁷ We recommend that you allow for a 15-minute warmup from a cold start.

3 Install Your Scanner

A horizontal Safety Zone is considered to be 30° or less from a level floor or walking surface.

1. Determine the area to be safeguarded by the scanner.
2. Determine whether to install the SX5 with or without a Banner mounting option.
3. Determine the size and coverage of the Safety Zone and Warning Zone (if used) depending on: physical location of the scanner installation, and the minimum safety distance or the stopping distance of the mobile vehicle.
See [Minimum Safety \(Separation\) Distance for Stationary Applications](#) on page 29 and [Mobile Applications](#) on page 33.
4. Determine the restart operating mode (manual or automatic reset). See [Automatic or Manual Start/Restart](#) on page 53.
5. If Manual restart is used, determine the location for the reset switch, see the reset switch location section of the manual.
6. Determine if a Zone Set switchover is required and identify the conditions for use.
7. Configure the SX5 with the configuration software.
8. Record the SX5 configuration and the Safety/Warning Zone dimensioning. This document should identify and be signed by the individual(s) responsible for the configuration and be included with the machine documentation.
9. For stationary applications, it is recommended to mark the perimeter of the Safety Zone(s) on the floor as an awareness means for individuals in the area. For mobile applications, it is recommended that the diagram be readily available for review.
10. If required, install means to protect the SX5 from physical damage, sources of optical interference (e.g. other scanners), or prevent the SX5 from being used as a climbing aid. Ensure that these means do not impair the SX5's field of view.

3.1 Safety Zone (SZ) and Warning Zone (WZ) Considerations

- Ensure the dimension (size) and coverage of the Safety Zone can detect an intrusion and allow the scanner's OSSDs to stop the dangerous movement before personnel can access the hazard. (See [Minimum Safety \(Separation\) Distance for Stationary Applications](#) on page 29 and [Minimum Distance D \(Safety Zone Length\) for Mobile Applications](#) on page 34.)
- Ensure that access to all hazards is not possible for all Zone Set switchover applications.
- Ensure that safety distance and stopping distance calculations incorporate all factors that can effect response time, including:
 - The additive effect of all device response times, such as the scanner, UM-FA-... safety module, and all machine control elements (FSDs and/or MPCEs).
 - Add the appropriate response time values to account for any reasonably foreseeable machine stop time degradation, such as due to brake pad wear.
- Ensure that the Safety Zone adequately covers all access routes that may lead to the safeguarded hazard or supplemental guarding may be required (see [Unmonitored Areas](#) on page 23).
- Ensure that the safeguarded hazard(s) cannot be accessed because of the effect of "shadowing" within the Safety Zone by adding supplemental safeguarding, such as additional scanners.
- Observe the lateral tolerance when dimensioning the Safety Zone (e.g. do not use needle or cone-shaped boundaries to define the separation (safety) distance; cone-shaped boundaries rely on less accurate, angular resolution measurements).
- Consider and resolve any other application factors that might require an increase in the separation (safety) distance or stopping distance. These factors should be identified via the risk assessment process.
- Determine if the reference points (surface) monitoring function is required (especially in vertical applications). This function prevents unintentional misalignment and deliberate manipulation of the SX5 (see [Reference Points \(Surface\) Monitoring](#) on page 16).

3.2 Mechanical Installation Considerations

Many factors influence the layout of the SX5's mechanical installation. For stationary applications, these include separation (safety) distance, supplemental safeguarding (hard guarding), unmonitored areas (shadows or areas behind the SX5), adjacent SX5s, and the height of the Safety Zone (in horizontal applications). In addition, mobile applications must take into account the stopping performance and distance of the mobile vehicle the SX5 is controlling.



WARNING: The Hazard Must Be Accessible Only through the Sensing Field

The installation of the SX5 must prevent any individual from reaching around, under, over or through the sensing field and into the hazard without being detected. Mechanical barriers (for example, hard (fixed) guarding) or supplemental safeguarding may be required to comply with this requirement, and is described by ANSI B11.19 safety requirements or other appropriate standards. **Failure to follow these instructions could result in serious injury or death.**

3.2.1 Unmonitored Areas



WARNING:

- Unmonitored areas can create an access route to the hazard or a blind zone where a person cannot be detected. The area behind the Scanner and near it, on either side is not monitored.
- Failure to minimize the unmonitored area could result in serious bodily injury or death.
- Minimize the unmonitored area so that no one can access this area undetected (for example, by recessing the Scanner into the machine, using supplemental safeguarding, or using mechanical barriers to prevent access).

Behind and To the Sides of the Scanner

The area behind and on either side the SX5 is not monitored. It must not be possible to walk in unmonitored areas or otherwise access them. This can be accomplished by recessing the SX5 into the machine, using supplemental safeguarding, or using mechanical barriers to prevent access. If there is a possibility that the SX5 could be used as a climbing aid or standing surface, use a physical cover set at an angle over the SX5.

Special attention to these areas must be addressed in vertical Safety Zone applications so that the resolution at the edges of the Safety Zone does not increase. If an increased resolution cannot be prevented, then the worst-case resolution must be used to determine the **D_{pf}** (U.S. formula) or the **C factor** (European formula) in the safety distance calculations.

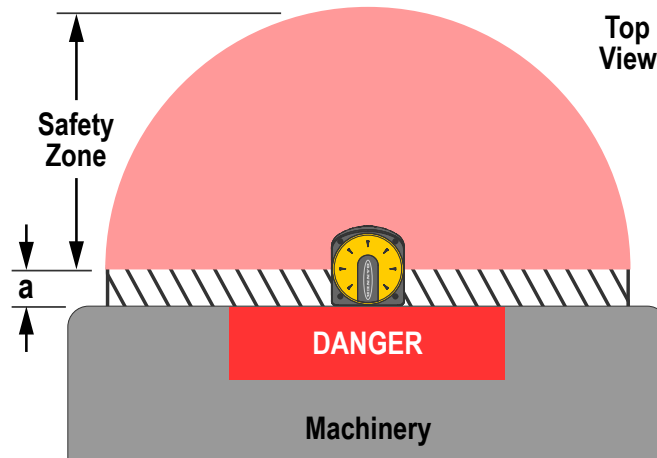

Figure 13. Safety Zone unmonitored areas

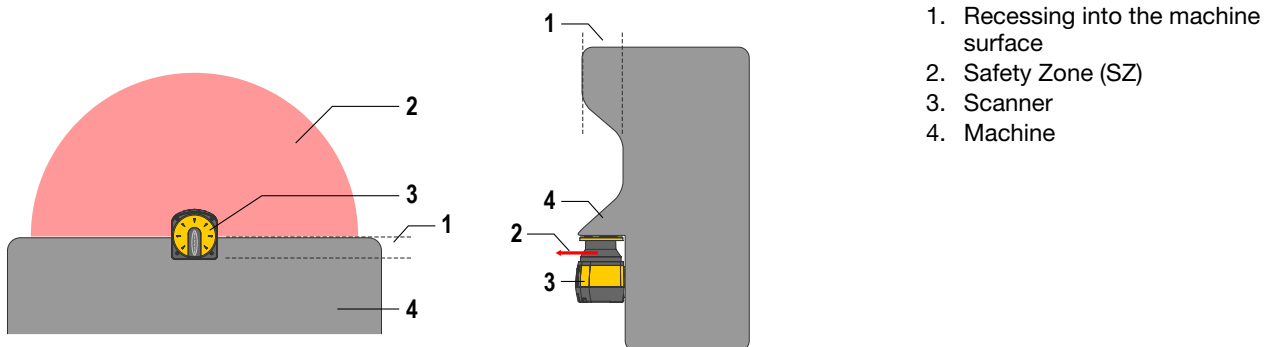

Figure 14. Mounting the scanner recessed into the machine

Shadowing Within the Safety Zone



WARNING:

- Permanent and moveable objects in the Safety Zone can create a shadow that results in an unprotected zone that may provide an access route to the hazard.
- Failure to eliminate access routes caused by the shadowing effect could create a potentially dangerous condition that may lead to serious injury or death.
- Eliminate any unprotected access routes by repositioning the SX5, installing additional SX5s, or by adding supplemental safeguarding.

Objects that are located within the Safety Zone create an unmonitored area directly behind the object. This area is best described as a shadow, since the light emitted by the SX5 cannot bend around or penetrate through solid objects. The shadow effect can be caused by both opaque and transparent objects.

Any unmonitored areas resulting from the shadow effect must not allow unprotected access routes to the hazard. This can be prevented by repositioning the SX5, installing additional SX5s, or by adding supplemental safeguarding.

If the object is moveable, such as a scrap bin, do one or more of the following:

- Locate the unmonitored area at a greater distance from the hazard than the calculated safety distance;
- Enable an alternate Zone Set when the object is relocated; or
- The moveable object must be interlocked to stop and prevent the safeguarded hazard, if the object is moved.
- Identify the object with Reference Points (see [Reference Points \(Surface\) Monitoring](#) on page 16)

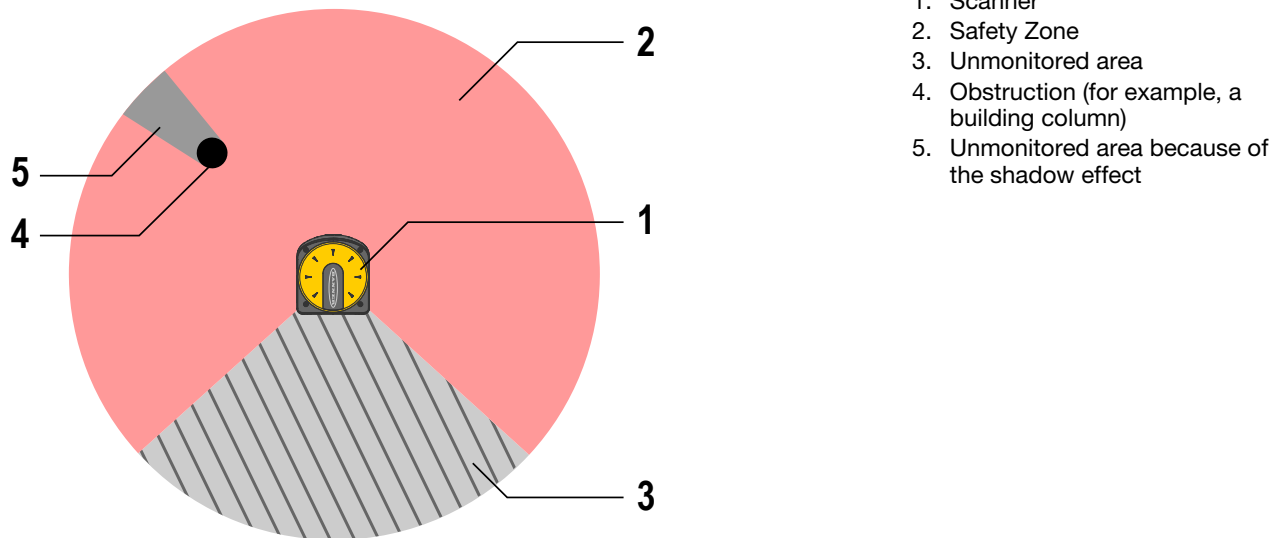

Figure 15. A shadow within the Safety Zone

Needle- and Cone-Shaped Safety Zone Contours



WARNING:

- Needle- and Cone-shaped Safety Zone contours
- Boundaries or contours that rely on too few measurement points (e.g., one or two) may not reliably turn OFF the OSSDs when an object is present.
- Any safety distance calculations must consider and resolve the effects of needle- or cone-shaped Safety Zones.

Needle- and cone-shaped Safety Zone boundaries are not recommended, because they may not reliably detect and respond to objects (for example, turn OFF the OSSDs), compared with smooth-field boundaries made up of multiple measurement points. Two effects are to be considered:

1. Not identifying the proper size of the detected object (outward cone shapes), and
2. An increase in resolution (inward cone shapes).

Outward Needle- and Cone-Shaped Field Contours — An object equal to or greater than the stated resolution (e.g., 70 mm) will be detected at point A (Object 1), because enough sensing points are present at that location to detect the full 70 mm size of the object.

Objects 2 or 3 may not be identified as being larger than the resolution because at that distance, the angle is too narrow (and has too few sensing points) to detect the full 70 mm resolution size.

Inward Needle- and Cone-Shaped Field Contours — The effect of an inward cone-shape is to increase the effective resolution immediately adjacent to the shape. For the Scanner to identify that an object is equal to or greater than the stated resolution (e.g., 70 mm), the entire object must be within the Safety Zone to turn OFF the OSSDs (e.g., Object 4). When an object enters the unmonitored cone-shaped area, the start/restart inhibit function will enable a reset as soon as the object portion within the Safety Zone is smaller than the stated resolution (Objects 5 and 6). This will turn ON the OSSDs if the configuration is set to automatic restart, or if the reset switch is actuated.

To prevent a safety distance that is too short at that point, the increased effective resolution must be used to determine the Dpf or C factor in the respective safety distance formulas. If a cone-shaped field must be used and the safety distance cannot be complied with, additional supplemental safeguarding must be used.

To verify Safety Zone effectiveness, perform a trip test.

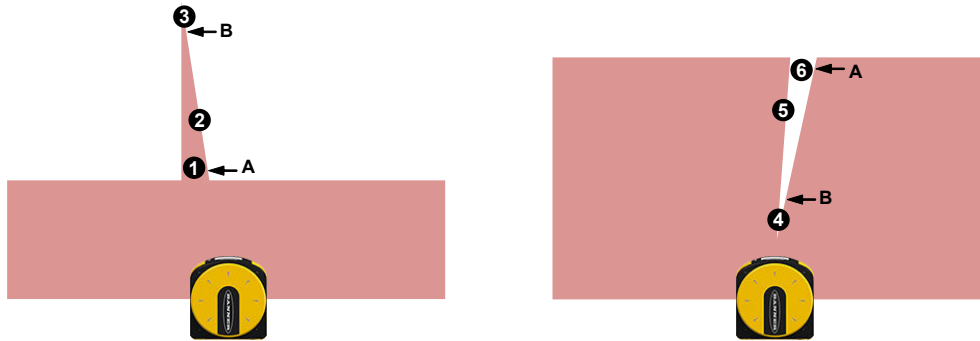

Figure 16. Example of inward and outward cone-shaped fields

3.2.2 Adjacent SX5s



WARNING:

- Interference from Adjacent SX5s
- Interference from adjacent SX5s may cause the OSSDs to go to the OFF state.
- SX5s with a clear line of sight to another SX5 and that share the same detection plane with it, must be adjusted or shielded so that their light pulses are not detected by the adjacent SX5s.

The SX5 design minimizes the possibility of optical interference from adjacent Scanners. Light from adjacent scanners (including those of other manufacturers) can cause OSSDs to go to the OFF state. To eliminate the possibility of optical interference causing the OSSDs to turn off:

- Install mechanical shielding/barriers in stationary applications (both horizontal and vertical Safety Zones).
- For scanners mounted side-by-side, this shielding must be at least at the height of the front screen (window) and flush with the front of the housing.
 - Ensure that the means of shielding does not create any unmonitored areas.
 - Install SX5s at an off-set height greater than the height of the scanner output window (60 mm).
- Install SX5s with Safety Zones with a crossed alignment.

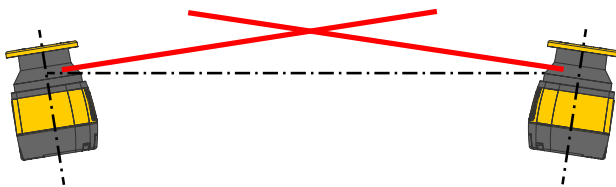

Figure 17. Scanners mounted at different scanning angles

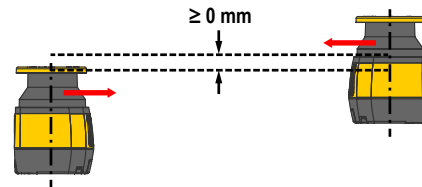

Figure 18. Scanner mounted at different scanning heights

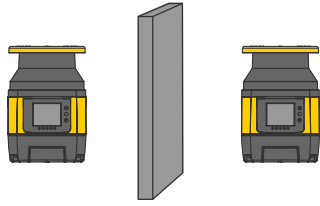

Figure 19. Shielding plate between scanners

3.2.3 Light Interference

Reflective surfaces located near the safety device may cause passive reflections. These reflections can affect the detection of an object inside the safety zone. The passive light sources can be an incandescent lamp, sunlight, a fluorescent light, a strobe light or other infrared light sources.

Do not install the SX5 Safety Laser Scanner near strong and/or flashing light sources.

Ambient light may interfere with the functioning safety laser scanner. If the installation requires direct exposure to ambient light, the scanner must be positioned so that the light does not enter the output window within $\pm 5^\circ$ of the detection plane.

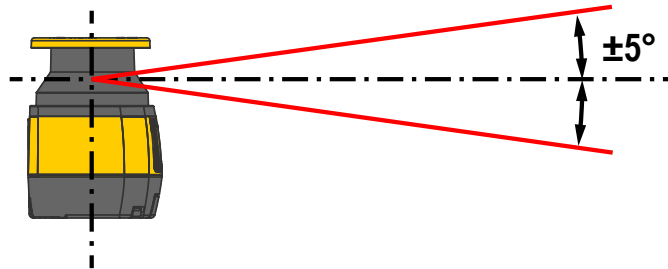

Figure 20. Position the scanner to avoid light interference



CAUTION: In all applications where strong light within $\pm 5^\circ$ of the detection plane cannot be avoided, apply an additional distance to the Minimum Safety Distance calculations. This distance also depends on the Dust Filter Level setting. See the chart below, the minimum safety distance calculation section ([Minimum Safety \(Separation\) Distance Formula](#) on page 30), and the dust filtering section ([Dust Filtering](#) on page 28).

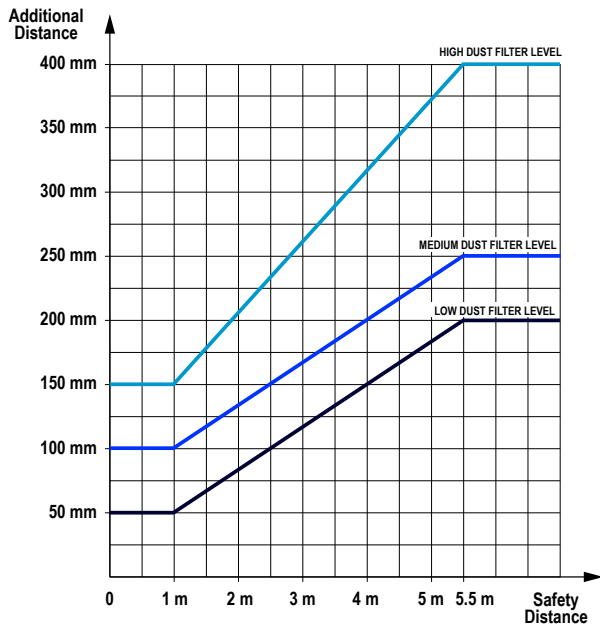

Figure 21. Additional distance for 70 mm resolution

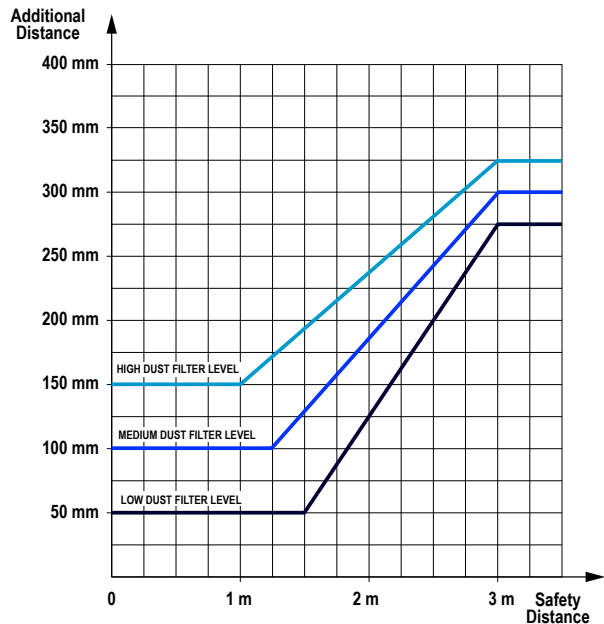

Figure 22. Additional distance for 40 mm resolution



CAUTION: In any case where bright light is present outside the $\pm 5^\circ$ range, the additional distance is still highly recommended.

3.2.4 Highly Reflective Backgrounds

If there is a highly reflective background within 3 meters of the safety zone boundary, for example a metallic glossy surface, the SX5 Safety Laser Scanner might fail to recognize the exact distance of the detected object.

In this situation, it is recommended to reduce or remove the reflecting background. See [Figure 21](#) on page 26 and [Figure 22](#) on page 26.

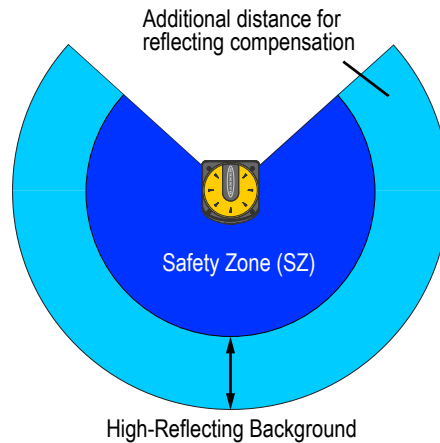

Figure 23. Reduce or remove a highly reflecting background



CAUTION: In all applications where highly reflective backgrounds within 3 meters of the Safety Zone boundary cannot be avoided, an additional distance must be applied to the Minimum Safety Distance calculations. This distance also depends on the Dust Filter Level setting. See the additional distance charts (in [Light Interference](#) on page 26), minimum safety distance calculation section ([Minimum Safety \(Separation\) Distance Formula](#) on page 30), and the dust filtering section ([Dust Filtering](#) on page 28).

3.2.5 Limited Detection Capability Zone

If the safety laser scanner is positioned in a limited detection capability zone, the device may not detect an object with low reflectance located at a distance of 100 mm or less from the safety zone origin (center of the scanner). This is the zone with limited detection capability.

In this circumstance, it is recommended to make the risk assessment take into account the possibility that an object can cross a zone with limited detection capability. If possible, responsible personnel must provide an additional solution.

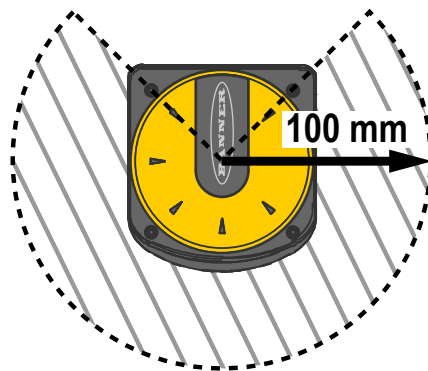

Figure 24. Limited detection capability zone

3.2.6 Dust Filtering

Set the Dust Filter Level according to different conditions specific to the application. In general, it is the sensitivity to various levels of airborne particles that impact the response of the SX5 Safety Laser Scanner detection.

Set the Dust Filter Level to the lowest value that still allows the machinery to work without detecting dust.

- Use a **LOW** dust filter level (default in the configuration software) in cleaner environments where airborne particles have little effect on object detection.
- Use a **MID** dust filter level in environments where some airborne particles are present and can influence object detection.
- Use a **HIGH** dust filter level in dirty environments to filter (ignore) detection of airborne particles to ensure that they do not cause the scanner to detect objects in the zone set when nothing is present. This makes the SX5 Safety Laser Scanner less sensitive to dust and avoids shutting down the machinery unnecessarily.

The Dust Filter Level setting affects the additional distance that must be applied to the Minimum Safety Distance Calculations (*Minimum Safety (Separation) Distance Formula* on page 30). In addition to the level of airborne particles in the safety laser scanner's environment, some special lighting conditions also affect the detection sensitivity. These special lighting conditions are:

- The presence of bright light within $\pm 5^\circ$ of the detection plane (see *Light Interference* on page 26).
- Highly reflective backgrounds within 3 m of the Safety Zone boundary (see *Highly Reflective Backgrounds* on page 27).



WARNING: These special conditions require additional distance to be added to the Minimum Safety Distance calculations to avoid a person or object arriving at the danger zone before the machine shuts off. This distance also depends on the Dust Filter Level setting.

3.3 Positioning Horizontal Safety Zones for Stationary Applications

Height of the Safety Zone Above the Floor or Walking Surface – The Safety Zone should not be located more than 1000 mm above the floor H.

Where $H > 300$ mm, there is a risk that a person can go undetected. In this case, supplemental guarding may be required. The minimum allowable height of the Safety Zone (H) is a function of the scanner's detection capability (resolution) and is calculated using the following formula:

$$H = 15 \times (d - 50 \text{ mm}) \text{ or } H = 15 \times (d - 2 \text{ in}) \text{ where}$$

d = the Scanner's Detection Capability (Resolution)

H = the distance of the Safety Zone above the walking surface

Detection Capability (Resolution) (d)	Minimum Height (H)
≤ 50 mm (2 in)	0
70 mm (2.8 in)	300 mm (12 in)
90 mm (3.5 in)	600 mm (24 in)
117 mm (4.6 in)	1000 mm (39 in)
H should not be greater than 1000 mm (39 in)	

This ensures detection of a given body part (e.g., thigh, leg, ankle) for a given resolution. For example, a Safety Zone with 70 mm resolution may not reliably detect an ankle (which requires a 50 mm resolution). Thus, the 70 mm resolution Safety Zone is intended to reliably detect a leg and should be mounted 300 mm or more above the walking surface.

For a given Safety Zone height, the corresponding maximum detection capability (resolution) d can be calculated using the following formula:

$$d = (H/15) + 50 \text{ mm or } d = (H/15) + 2 \text{ in}$$

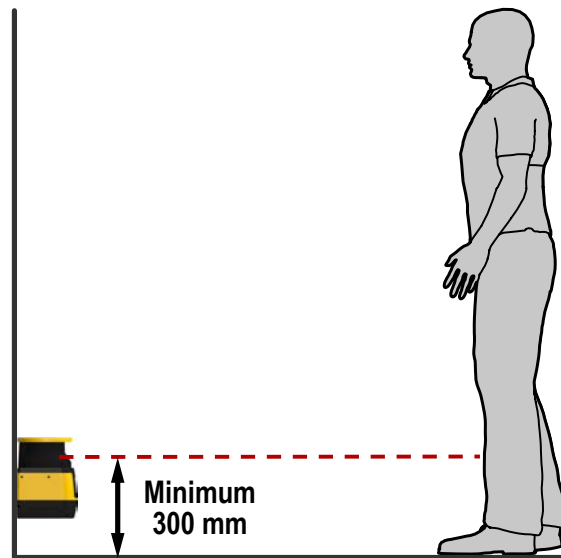

Figure 25. A zone with 70 mm resolution is mounted no lower than 300 mm above the floor



WARNING:

- Safety Zone height (stationary horizontal fields)
- Where the height of a horizontal Safety Zone is $H > 300$ mm, there is a risk that a person can go undetected beneath the field.
- If it is possible for an individual to crawl undetected under the Safety Zone and access the hazard, install supplemental guarding to prevent this access.

3.4 Minimum Safety (Separation) Distance for Stationary Applications

Response Time Considerations — The SX5's mirror rotates every 30 ms (33.3 scans [revolutions] per second). The safety outputs will switch off only after an object is detected in the Safety Zone for at least two consecutive scans. The SX5's minimum response time is therefore 62 ms (2×30 ms + 2 ms).

To increase the SX5's reliability in an adverse environments (e.g., with fine airborne particles), increase the number of scans required before the scanners safety outputs turn off. With each additional scan the response time (T_r) increases by 30 ms. With $K = 1600$ mm/s the separation (safety) distance increases by 48 mm per additional scan.



WARNING:

- **Scanner Response Time Adjustments**
- Failure to follow this recommendation could result in serious bodily injury or death.
- Do not increase the SX5's 62 ms response time for vertically positioned Safety Zones such as work cell access (Entry/ Exit) or perimeter guarding applications where a person could move quickly through the Safety Zone without being detected.

The Safety Zone must maintain a tolerance of at least 40 mm from any wall or fixed object.



WARNING:

- Determine the correct stop time (T)
- An incorrect stop time can lead to serious bodily injury or death. Be sure to include the stop time of all relevant devices and controls in the calculations.
- Stop time (T) must include the response time of all devices or controls that react to stop the machine. If all devices are not included, the calculated Safety distance (S) will be too short.



WARNING:

- Maintain the proper safety distance
- Failure to establish and maintain the minimum safety distance could result in serious bodily injury or death.
- Locate the Safety Zone far enough from the nearest hazard such that an individual cannot reach the hazard before cessation of hazardous motion or situation.

3.5 Minimum Safety (Separation) Distance Formula

When all factors that influence the Safety Distance are considered, the formula is:

For US Applications	For European Applications
<p>$D_S = [K \times (T_S + T_R)] + D_{pf} + Z_{SM} + Z_{amb}$ where</p> <p>D_S = the safety distance, in mm (inches) K = 1600 mm per second (63 inches per second) (see note 1 below) T_S = maximum stopping time (sec) of the machine (see note 2 below) T_R = maximum response time (sec) of the Scanner (see note 3 below) D_{pf} = Depth penetration factor: The additional distance required by U.S. standards, such as ANSI B11.19, to prevent a person from encroaching towards the hazard without being detected. Z_{SM} = the additional distance needed to account for distance measurement error. Z_{amb} = the additional distance needed to account for error due to reflections from retroreflective surfaces.</p> <p>Notes:</p> <ol style="list-style-type: none"> 1. The OSHA-recommended hand speed constant K has been determined by various studies, and although these studies indicate speeds of 1600 mm/s (63 in/s) to more than 2540 mm/s (100 in/s), they are not conclusive determinations. Consider all factors, including the physical ability of the operator, when determining the value of K to be used. 2. T_S is usually measured by a stop-time measuring device. If the machine manufacturer's specified stop time is used, add at least 20% to allow for possible clutch/brake system deterioration. This measurement must take into account the slower of the two MPCE channels, and the response time of all devices or controls that react to stop the machine (e.g., UM-FA-9A safety module). See Notice Regarding MPCEs. If all devices are not included, the calculated safety distance (D_S) will be too short and serious injury could result. <p>Dpf Considerations</p> <p>Horizontal Safety Zone Applications (parallel approach) $D_{pf} = 1200$ mm (48 in)</p> <p>Scanner-Specific Additional Distance Factors — Two Scanner-specific factors must be considered when calculating the Minimum Safety distance: Z_{SM} and Z_{amb}</p> <p>Z_{SM} Measurement Tolerance Factor — Z_{SM} is the additional distance needed to account for distance measurement error. The value for Z_{SM} is 150 mm (5.9 in). For Vertical Safety Zones (normal approach), $Z_{SM} = 0$</p>	<p>$S = (K \times T) + C + Z_{SM} + Z_{amb}$ where</p> <p>S = the minimum distance between the hazard and the Safety Zone. S is never less than 100 mm (4 in) K = approach speed (see note 1 below) 2000 mm/s (79 in/s) for $S < 500$ mm (20 in) 1600 mm/s (63 in/s) for $S > 500$ mm (20 in) T = overall system stopping performance in seconds (see note 2 below) C = an additional distance in millimeters (inches), based on intrusion towards the hazard prior to actuation of the Scanner. This value is never less than zero. Z_{SM} = the additional distance needed to account for distance measurement error. Z_{amb} = the additional distance needed to account for error due to reflections from retroreflective surfaces.</p> <p>Notes: The above formula is derived from ISO 13855 (2002).</p> <ol style="list-style-type: none"> 1. If S is greater than 500 mm, then $K = 1600$ mm/s can be used instead of the 2000 mm/s speed, however, if the 1600 mm/s value is used, then S can never be less than 500 mm. 2. T is the time from the actuation of the sensing function to the machine's assuming a safe condition, comprising a minimum of two phases: $T = t_1 + t_2$ where <p>t_1 is the maximum time between the actuation of the sensing function and the output signal switching devices (OSSDs) being in the OFF state. This is the response time of the SX5.</p> <p>t_2 is the maximum response time of the machine, i.e. the time required to stop the machine or remove the risks after receiving the output signal from the protective equipment. t_2 is influenced by temperature, switching time of valves, ageing of components, and other factors. t_2 is usually measured by a stop-time measuring device. If the machine manufacturer's specified stop time is used, add at least 20% to allow for possible clutch/brake system deterioration. This measurement must take into account the slower of the two MPCE channels, and the response time of all devices or controls that react to stop the machine (e.g., UM-FA-9A safety module). If all devices are not included, the calculated safety distance (D_S) will be too short and serious injury could result.</p> <p>Distance Adjustment C, Based on the Possible Field Intrusion</p> <p>Horizontal Safety Zone Applications (Parallel Approach) $C = 1200$ mm – $(0.4 \times H)$ or $C = 48$ in – $(0.4 \times H)$ where H is the distance of the Safety Zone above the floor or walking surface (1000 mm maximum). C can never be less than 850 mm (34 in).</p> <p>Additional Scanner-Specific Distance Factors</p> <p>Two Scanner-specific factors must be considered when calculating the Minimum Safety distance: Z_{SM} and Z_{amb}</p> <p>Z_{SM} Measurement Tolerance Factor—Z_{SM} is the additional distance needed to account for distance measurement error. The value for Z_{SM} is 150 mm (5.9 in). For Vertical Safety Zones (normal approach), $Z_{SM} = 0$</p>

Z_{amb} (Ambient Interference Factor) is the additional distance needed to account for measurement errors due to light interference and/or reflections from highly reflective or shiny surfaces that are present in the scanning plan.

No ambient interference $Z_{amb} = 0$

Ambient Interferences present Z_{amb} = Value interpreted from the graph based on dust filter level

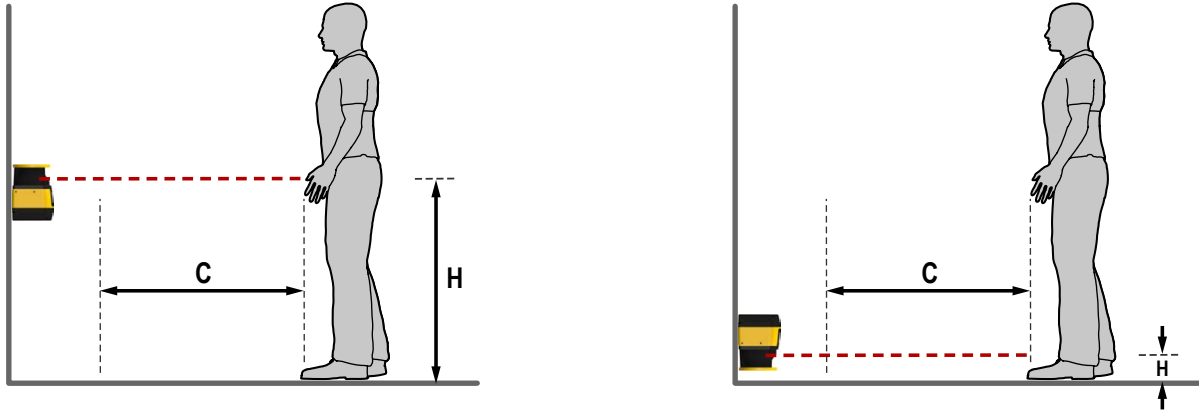

Figure 26. Calculating the safety distance for each resolution

US Information Dpf Considerations for Vertical Safety Zone Applications (Normal Approach)

For Detection Capability (Resolution), where $d \leq 64$ mm (2.5 in), i.e. 40 mm, the formula for Dpf is: $Dpf = 3.4 \times (d - 7$ mm) or $Dpf = 3.4 \times (d - 0.275$ in)

Where d = the scanner's detection capability (resolution)

For Detection Capabilities (Resolution) of $d > 64$ mm (2.5 in), i.e. 70 mm, Dpf is 900 mm (36 in)

For a Detection Capability (Resolution) of 40 mm the Dpf is 112 mm (4.5 in)

European Information Distance Adjustment C, Based on the Possible Field Intrusion for Vertical Safety Zone Applications (Normal Approach)

For a Resolution of 40 mm (1.6 in), the formula for C is: $C = 8 \times (d - 14$ mm) or $C = 8 \times (d - 0.55$ in)

Where d = the scanner's detection capability (resolution)

For a resolution of 70 mm (2.8 in): $C = 850$ mm (34 in)

For a Detection Capability (Resolution) of 40 mm, C is 208 mm (8.2 in)

3.6 Reducing or Eliminating Pass-Through Hazards

A *pass-through* hazard is associated with applications where personnel may pass through a safeguard, such as the SX5 Safety Laser Scanner (which issues a stop command to remove the hazard), and then continues into the guarded area. This is common in access and perimeter guarding applications. Subsequently, their presence is no longer detected, and the related danger becomes the unexpected start or restart of the machine while personnel are within the guarded area.

A pass-through hazard typically results from large safety distances calculated from long stopping times, large minimum object sensitivities, reach-over, reach-through, or other installation considerations. A pass-through hazard can be generated with as little as 75 mm (3 in) between the sensing field and the machine frame or hard (fixed) guarding.

Eliminate or reduce pass-through hazards whenever possible. While it is recommended to eliminate the pass-through hazard altogether, this may not be possible due to machine layout, machine capabilities, or other application considerations.

One solution is to ensure that personnel are continually sensed while within the hazardous area. This can be accomplished by using supplemental safeguarding, such as described by the safety requirements in ANSI B11.19 or other appropriate standards.

An alternative method is to ensure that once the safeguarding device is tripped it will latch and will require a deliberate manual action to reset. This method of safeguarding relies upon the location of the reset switch as well as safe work practices and procedures to prevent an unexpected start or restart of the guarded machine. The SX5 Safety Laser Scanner provides a configurable Manual Start/Restart (Latch Output) function for these applications.

**WARNING: Use of the Banner device for Access or Perimeter Guarding**

If a Banner device is installed in an application that results in a pass-through hazard (for example, perimeter guarding), either the Banner device or the Machine Primary Control Elements (MPCEs) of the guarded machine must cause a Latched response following an interruption of the defined area.

The reset of this Latched condition may only be achieved by actuating a reset switch that is separate from the normal means of machine cycle initiation.

Lockout/Tagout procedures per ANSI Z244.1 may be required, or additional safeguarding, as described by ANSI B11.19 safety requirements or other appropriate standards, must be used if a passthrough hazard cannot be eliminated or reduced to an acceptable level of risk. **Failure to follow these instructions could result in serious injury or death.**

3.7 Reset Switch Location

Mount the reset switch at a location that complies with the warning and guidelines below. If any hazardous areas are not in view from the switch location, additional means of safeguarding must be provided. The switch should be protected from accidental or unintended actuation (for example, through the use of rings or guards).

A key-actuated reset switch provides some operator or supervisory control, as the key can be removed from the switch and taken into the guarded area. However, this does not prevent unauthorized or inadvertent resets due to spare keys in the possession of others, or additional personnel entering the guarded area unnoticed. When considering where to locate the reset switch, follow the guidelines below.

**WARNING: Reset Switch Location**

When considering where to locate the reset switch, you must follow the guidelines outlined in this section.

If any areas within the guarded area are not visible from the reset switch, additional safeguarding must be provided, as described by the ANSI B11.19 series or other appropriate standards.

Failure to follow these instructions could result in serious injury or death.

All reset switches must be:

- Outside the guarded area
- Located to allow the switch operator a full, unobstructed, view of the entire guarded area while the reset is performed
- Out of reach from within the guarded area
- Protected against unauthorized or inadvertent operation (such as through the use of rings or guards).



Important: Resetting a safeguard must not initiate hazardous motion. Safe work procedures require a start-up procedure to be followed and the individual performing the reset to verify that the entire hazardous area is clear of all personnel before each reset of the safeguard is performed. If any area cannot be observed from the reset switch location, additional supplemental safeguarding must be used: at a minimum, visual and audible warnings of machine start-up.

3.8 Supplemental Safeguarding

Position the scanner components so an individual cannot reach through the defined area and access the hazard point before the machine has stopped.

Additionally, the hazard cannot be accessible by reaching around, under, or over the defined area. To accomplish this, install supplemental guarding (mechanical barriers, such as screens or bars), as described by ANSI B11 safety requirements or other appropriate standards. Access must only be possible through the defined area of the Scanner or through other safeguarding that prevents access to the hazard.

The mechanical barriers used for this purpose are typically called hard guarding; there must be no gaps between the hard guarding and the defined area. Any openings in the hard guarding must comply with the safe opening requirements of ANSI B11 or other appropriate standard.



WARNING: The Hazard Must Be Accessible Only through the Sensing Field

The installation of the SX5 must prevent any individual from reaching around, under, over or through the sensing field and into the hazard without being detected. Mechanical barriers (for example, hard (fixed) guarding) or supplemental safeguarding may be required to comply with this requirement, and is described by ANSI B11.19 safety requirements or other appropriate standards. **Failure to follow these instructions could result in serious injury or death.**

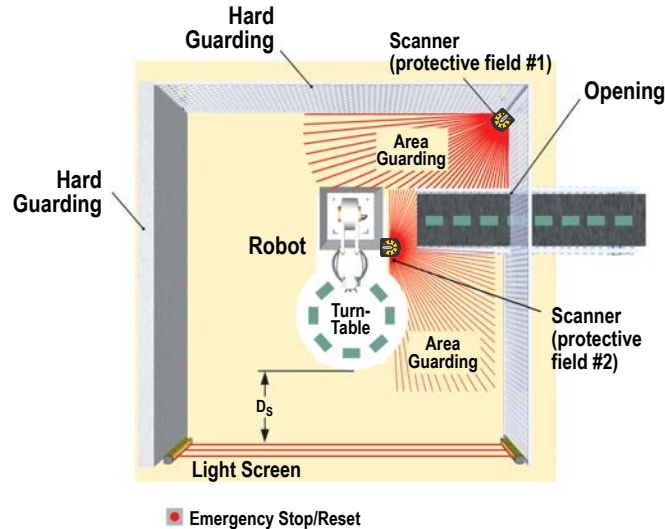

Figure 27. Supplemental safeguarding inside a robotic work cell

This shows an example of supplemental safeguarding inside a robotic work cell. The safety light screen, in conjunction with the hard guarding, is the primary safeguard. Supplemental safeguarding (such as scanners used as area guards) is required in areas that cannot be viewed from the reset switch (for example, behind the robot and the conveyor). Additional supplemental safeguarding may be required to prevent clearance or trapping hazards (e.g., the safety mat as an area guard between the robot, the turntable, and the conveyor).

3.9 Mobile Applications

The SX5 can protect individuals entering an area with a variable or moving hazard, protect individuals and objects located within a mobile vehicle's path, and protect the mobile vehicle and its load from collisions.

Only use the SX5 on vehicles with electrical drives (e.g. servo) or electrically controlled drive and braking. The Safety Zone must be configured so that the mobile vehicle can come to a complete stop before a collision can occur. If it is not possible to completely safeguard the vehicle, including trailers, protruding or overhanging loads, etc., during the full length of travel, including curves, use additional safeguarding, such as additional SX5 or bumper/edge switches.

The following instructions are general in nature and are intended to provide guidance to safely install the SX5 on mobile vehicles. It is not possible to give exact recommendations for all mobile applications; the designer/user must also comply with the vehicle manufacturer's recommendations and all applicable regulations and standards. See also the warning and the basic installation guidelines.

Safety standards covering mobile vehicles or automated/automatic guided vehicles (AGV) include:

- BS/DIN EN 1525 —Driverless Industrial Trucks and Their SystemsII
- ISO 3691-4 —Driverless Industrial Trucks and Their SystemsII
- ANSI/ITSDF (ASME) B56.5 —Safety Standard for Guided Industrial VehiclesII
- IEC 61496-3 —Requirements for Active Opto-Electronic Protective Devices Responsive to Diffuse Reflection (AOPDDR)II

The user must also regularly check the safeguarding function of the SX5, and the speed and braking functions of the mobile vehicle (see [Initial Checkout](#) on page 49).

The user must instruct all individuals that may interact with the mobile vehicle (at a minimum) to:

- not approach the vehicle directly or from the sides while moving
- familiarize themselves with warning signals or lights/beacon
- familiarize themselves with the size of the Warning and Safety Zones

3.9.1 Safety Zone Area - Length and Width

The horizontal Safety Zone will prevent a collision only if the edge of the field in the direction of movement is sufficiently distant from the vehicle and its load. This dimension (length) of the Safety Zone is described as the Minimum Distance D. The Side Distance Z (or the width of the Safety Zone) is used to ensure that the sides of the vehicle or a protruding load do not create a hazard.

It is highly recommended that an oversized Warning Zone (in comparison to the Safety Zone) be used. The Warning Zone and its associated output signal the approach of the mobile vehicle (e.g., by sounding a horn or illuminating lights/beacons), and reduce the speed of the mobile vehicle. This can reduce the need or the amount of braking and wear on the drive mechanisms.

The Safety Zone configuration must take into account trapping/crushing hazards that could be created by physical objects near the path of the mobile vehicle. An example would be an elevated conveyor that the sensing field of the Side Distance Z passes under, but does not provide enough clearance. This situation can occur if the distance between the end of the conveyor and the side of the mobile vehicle is less than 500 mm (20 in) per ISO 13854 (EN349) Minimum Gaps to Avoid Crushing.

The following items apply to the calculation for determining the Minimum Distance D (Safety Zone length):

- Maximum speed of the AGV (Do not rely on the speed reduction initiated by the Warning Zone!)
- The SX5 response time
- The response time of the mobile vehicle drive logic, including the response time of any interfacing devices, such as UM-FA-...A safety module (25 ms)
- The braking distance of the AGV (including environmental conditions, such as wet or slippery flooring)
- Absence or lack of clearance in front or to the sides of the AGV
- The speed of movement of an individual
- The reduced efficiency of the braking system, due to wear



WARNING:

- **Calculate the correct stop time**
- Failure to follow these instructions could result in serious injury or death.
- The Stop Time (TS) must include the response time of all relevant devices or controls that react to stop the mobile vehicle. If all devices are not included, the calculated Minimum Distance (D) will be too short.



WARNING:

- Maintain the proper separation distance
- Failure to establish and maintain the Minimum Distance D could result in serious bodily injury or death.
- Locate the Safety Zone far enough from the nearest hazard such that an individual cannot reach the hazard before cessation of hazardous motion or situation.

3.9.2 Minimum Distance D (Safety Zone Length) for Mobile Applications

The following calculations do not specifically take into account the speed of an individual since it can be assumed that an individual will recognize and will avoid the hazard or at a minimum stop their movement. If this cannot be reasonably expected, such as if the Warning Zone is not used to signal the approach of the vehicle, the factor Z_A should incorporate the expected speed of an individual.

When all factors that influence a mobile vehicle stopping performance are considered, the formula is: $D = D_{SD} + Z_{SM} + Z_{amb} + Z_F + Z_A$ where:

D = Minimum distance from the vehicle surface to the edge of the Safety Zone in mm

D_{SD} = Stopping distance in mm

Z_{SM} = the additional distance needed to account for distance measurement error.

Z_{amb} = the additional distance needed to account for error due to reflections from retro reflective surfaces.

Z_F = the additional distance needed to account for AGV ground clearance

Z_A = application specific additions

Note: In the following figure, $Z_{LEAD} = Z_{SM} + Z_{amb} + Z_F + Z_A$

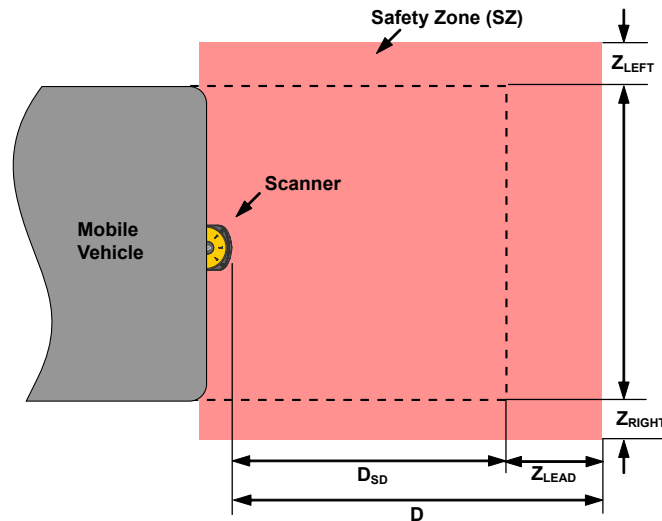

Figure 28. Calculating the minimum distance in a mobile vehicle application

$$D_{SD} = [V_{MAX} \times (T_S + T_R)] + D_B$$

where:

D_{SD} = Stopping distance in mm

V_{MAX} = the maximum velocity as stated by the manufacturer of the mobile vehicle

T_S = maximum stop time (in seconds) of the mobile vehicle (see note 1 below)

T_R = maximum response time (in seconds) of the Scanner (see note 2 below)

D_B = Braking Distance at full load and speed as stated by the manufacturer of the mobile vehicle and other environmental factors (see note 3 below)

Notes

1. T_S for the mobile vehicle should be supplied by its manufacturer. T_S must include the response time of all devices or controls that react to stop the vehicle (e.g., UM-FA-9A Safety Module), which are added to determine the total time to cause braking/stopping. If all devices are not included, the calculated distance (D_{SD}) will be too short and serious injury could result.
2. Braking Distance (D_B) should incorporate factors such as brake deterioration and environmental factors that can impact braking (such as loose dirt/gravel, wet/moisture, icing, etc.) which can add 10% or more to the manufacturer's stated distance. It should be noted that braking distance is not a linear function; it increases by a square function as velocity increases.

3.9.3 Additional Distance Factors (Z) Specific for Mobile Applications

For mobile applications, two additional factors must be considered: Z_{SM} and Z_{amb} .

Z_{SM} Measurement Tolerance Factor—For Horizontal Safety Zones (parallel approach): $Z_{SM} = 150$ mm.

Z_{amb} Retro Reflector Factor—The additional distance needed to account for measurement errors due to light interference (see section 3.x.4) and/or reflections from highly reflective or shiny surfaces that are present in the scanning plan.

- No ambient interference $Z_{amb} = 0$
- Ambient Interferences present $Z_{amb} =$ Value interpreted from the graph based on dust filter level

Z_F Mobile Vehicle (AGV) Ground Clearance— The additional distance Z_F is required if the mobile vehicle does not have sufficient ground clearance (HF) such that there is no space under the vehicle or Scanner for the tips of feet. If the wheels are mounted near the side wall, always add an additional distance $Z_F \geq 150$ mm; otherwise Z_F is determined according to the following figure.

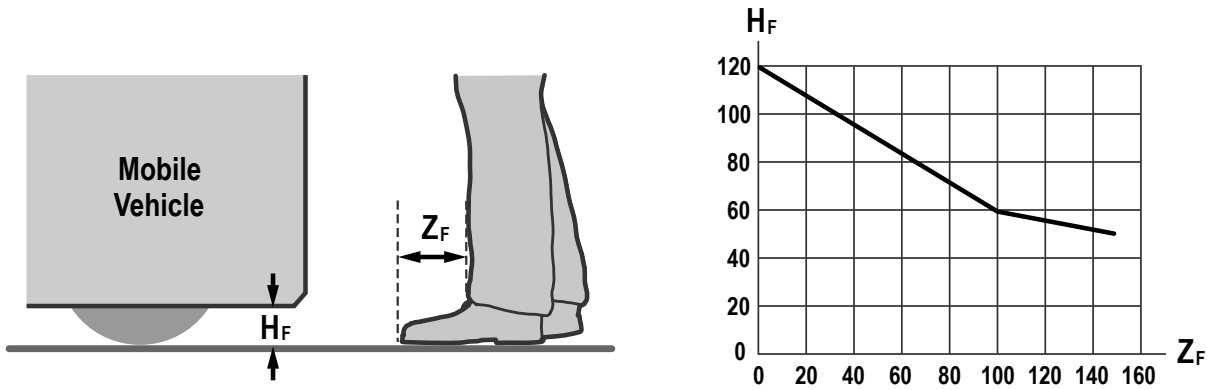

Figure 29. Diagram to determine the additional distance Z_F with lack of floor clearance H_F

Z_A Application-Specific Additions— Z_A is the additional distance needed to account for factors that can otherwise affect the safe application of the SX5. Examples include:

- Approach speed of an individual who is unaware of the vehicle's movement. ISO 13855 (Positioning of Safeguard with Respect to Approach Speed) defines walking speed as 1600 mm/s (63 in/s), thus $Z_A = 1600 \text{ mm/s} \times (T_S + T_R)$
- Additional clearance to avoid crushing, $Z_A = 500 \text{ mm}$ (20 in) per ISO 13854 (EN349)
- The effect of turning with long vehicles or trailers, resulting in large lateral travel

Multiple factors may or may not result in a cumulative effect: $Z_A = Z_{A1} + Z_{A2} + \dots + Z_{An}$. Evaluate each factor to determine its effect on all Additional Distance Factors (Z).

Additional Side Distance Z (Safety Zone Width)— The width of the Safety Zone is determined by the width of the mobile vehicle and the Additional Distance Factors (Z) as described. The distance Z may be different for the two sides and the leading edge. The width of the Safety Zone must be greater than the width of the mobile vehicle.

$$Z = Z_{SM} + Z_{amb} + Z_F + Z_A$$

It is important that the factor Z_A include the effect of turning with long vehicles or trailers, resulting in large lateral travel.

3.10 Mounting Your Scanner for Mobile Applications

The mounting of the SX5 should take into account:

- the surface contour of the path of the vehicle including holes, bumps, inclines, ramps, and other variations in the surface
- deflection of springs or other vibration dampeners that could cause the plane of the Safety Zone to vary
- unmonitored areas created by the installation of the SX5

The point of mounting is typically in the center of the leading edge of the vehicle and is aligned horizontally to achieve a consistent scanning height over the entire Safety Zone.

Mounting Height— Mount the SX5 as low as possible to prevent people from passing beneath the sensing field by lying on the floor. BS/DIN EN 1525 and IEC 61496-3 recommend that the Safety Zone with a resolution of 70 mm be as near as possible to the floor, but no greater than 200 mm (7.9 in) above the floor. In general, a height of 150 mm (5.9 in) has been recognized by industry to be the most advantageous height above the floor.

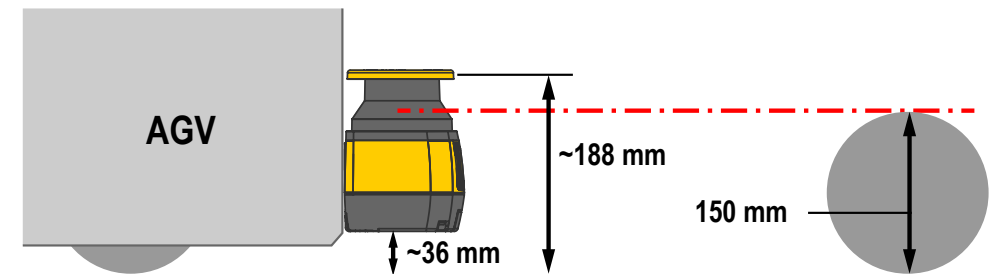

Figure 30. Diagram to determine the additional distance with lack of floor clearance

Unmonitored Areas— Mounting the SX5 on the mobile vehicle must not create unmonitored areas between the Safety Zone and the vehicle, such that the SX5 cannot respond to an object with a cross-section of 70 mm or more. Unmonitored areas on a mobile vehicle can be prevented by:

- Design/contour of the mobile vehicle
- Position of the Scanner

- Mounting the Scanner recessed within the vehicle
- Mounting the Scanner under a physical guard or overhanging parts of frame
- Using supplemental safeguarding, such as bumper or edge switches
- Using mechanical barriers to prevent access

3.10.1 Mounting the Scanner Directly to a Surface

The device has two M5 threaded holes on each side. For direct mounting, use both M5 threaded holes on a given side, taking into account the following values:

- M5 on the back (do not exceed 2.5 to 3 N·m torque), maximum depth of thread engagement 9.5 mm
- M5 on the side (do not exceed 2.5 to 3 N·m torque), maximum depth of thread engagement 8 mm



Important: For direct mounting on the sides, if the wall or panel obstructs the output window, this plane cannot be used for safety zone monitoring. The safety zone must adhere to the minimum distance to wall value.

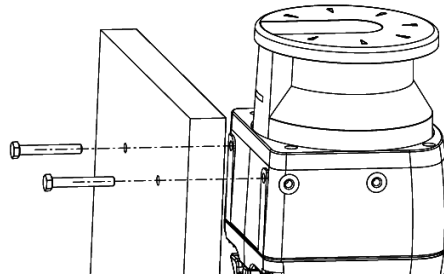

Figure 31. Mounting the scanner directly to a surface

The M5 UNI 5933 screws used for mounting the brackets to a wall are not supplied in the bracket mounting kits; they must be supplied by the user.

If the direct mounting procedure to the back is chosen, it is not possible to add the protection bracket to the device.

3.10.2 Mounting the Protection Bracket

The protection bracket is an optional accessory that provides protection to the scanner if it is located in an environment where the scanner may be hit by falling objects or subject to collision.

Fasten the protection bracket (1) on the back of the scanner using two M5 screws (2) (maximum of 3 N·m torque). Mount the SXA-MBK-2 bracket onto the scanner before the other fastening accessories.

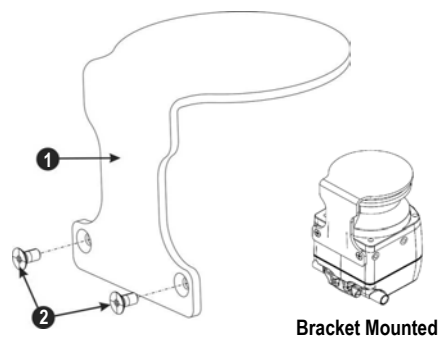

Figure 32. Mounting the protection bracket to the scanner



Important: This protection bracket consumes the mounting holes on the back of the unit. Use other holes to mount the scanner to the machine.

3.10.3 Mounting the Angle Adjustment Brackets

Provide two M5 holes with 73 mm spacing on the intended wall or mounting surface. The M5 UNI 5933 screws used for mounting the brackets to a wall are not supplied in the bracket mounting kits; they must be supplied by the user.

Pitch and roll angle adjustment bracket (SXA-MBK-1)—The bracket system is partially assembled.

1. Remove the M4 roll adjustment screws and washers (7), then align the M5 wall mounting screws (9).
2. Mount the roll adjustment bracket (8) to the wall or panel by inserting two M5 UNI 5933 screws (9). Tighten them, alternating between the two, until they are tight (torque to 2.5 to 3 N·m).
3. Place the assembly of (1) and (6) back onto the roll adjustment bracket (8) (or turn back into place) and re-install the M4 roll adjustment screws and washers (7). Do not tighten the M4 roll adjustment screws for the roll angle.

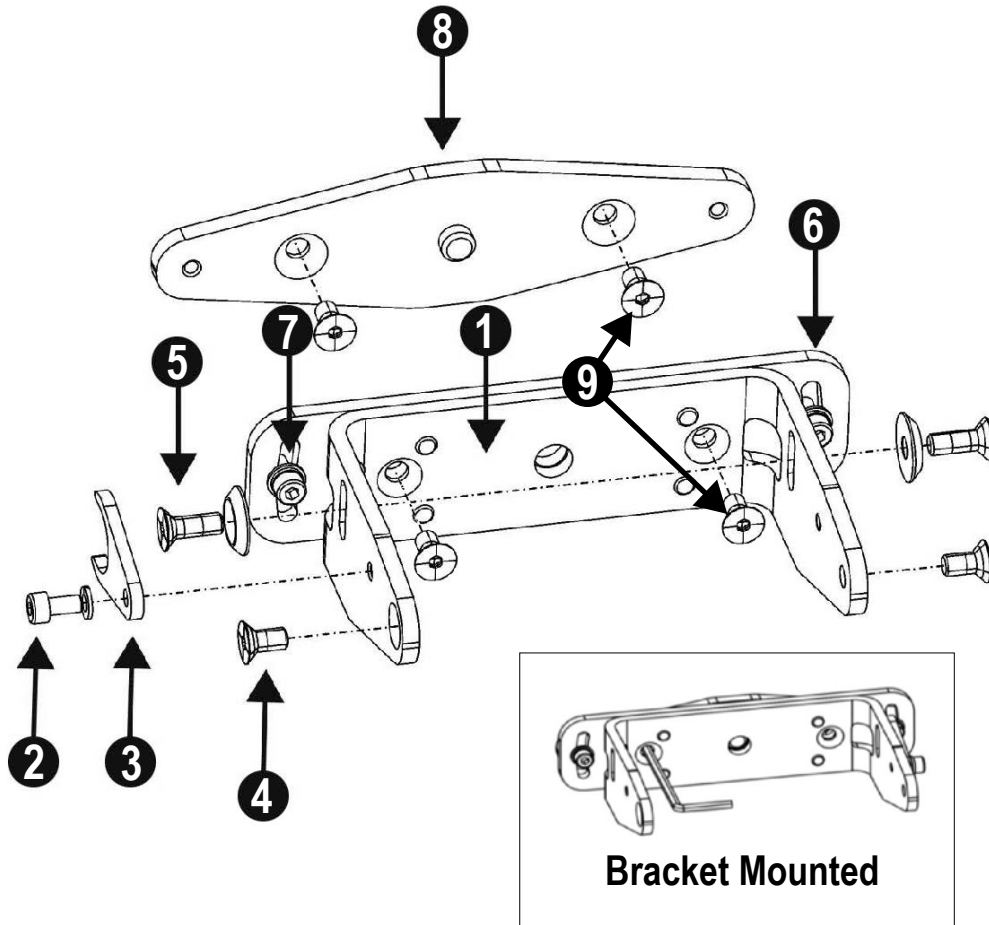

Figure 33. Pitch and roll angle adjustment bracket (SXA-MBK-1)

If only pitch adjustment is desired, the entire SXA-MBK-1 can be used with the roll adjustment centered (level) or the back plates (6 and 8) can be removed and only the pitch adjustment bracket (1) is used to mount the scanner. To remove 6 and 8 first remove the roll adjustment screws (7) to remove the back plate (8). Then remove the four screws that attach (6) to (1) from the back.

The pitch adjustment plate (1) can now be mounted to the 73 mm spaced holes using the M5 UNI 5933 screws (9). Tighten the screws, alternating between the two, until they are tight (2.5 to 3 N·m torque).

3.10.4 Mounting the Scanner and Adjusting the Angle

When mounting the brackets or scanner, do not exceed the listed torque or you will damage the scanner. The pitch angle adjustment procedure applies to both uses of the bracket assemblies.

The Positioning Memory Bracket (one piece) saves the inclination angle set for the installation. This allows for quick installation without further mechanical adjustments if it is ever necessary to replace the unit.

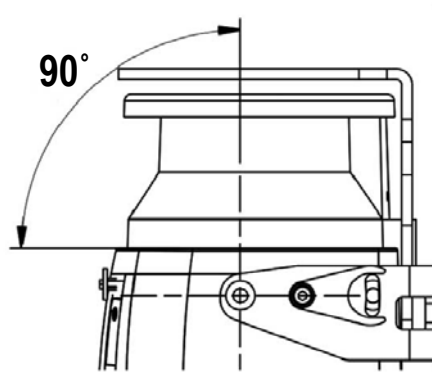

Figure 34. Adjust the scanner angle

To mount the device with 90° vertical inclination:

1. Mount the Positioning Memory Bracket (3) with the M4 screw (and washer) (2) to the main bracket (1) but do not tighten it.
2. Align the Positioning Memory Bracket with the center of the main bracket slot, then tighten the M4 screw (do not exceed 1.5 to 2 N·m torque).
3. Mount the scanner to the main bracket using the M5 × 12 Pitch Adjustment Screws (with washers) (5) and the M5 × 12 Scanner Fastening Screws (4). Tighten all four screws (do not exceed 2.5 to 3 N·m torque).

To place a device with a specific pitch angle:

1. Screw without tightening the M5 Scanner Fastening Screws, the M5 Pitch Adjusting Screws, and the Positioning Memory Bracket with the M4 screw.
2. Rotate the device to the desired pitch angle within the allowed range ($\pm 6^\circ$).
3. Tighten the M5 Scanner Fastening Screws and then the M5 Pitch Adjusting Screws (do not exceed 2.5 to 3 N·m torque).
4. Tighten the Positioning Memory Bracket M4 screw (do not exceed 1.5 to 2 N·m torque).

3.10.5 Adjusting the Roll Angle

The roll angle adjustment procedure only applies when all parts of bracket SXA-MBK-1 are used.

Rotate the brackets to reach the desired roll angle within the allowed range ($\pm 8.5^\circ$). Tighten the M4 Roll Adjusting Screws (7) (do not exceed 1.5 to 2 N·m torque).

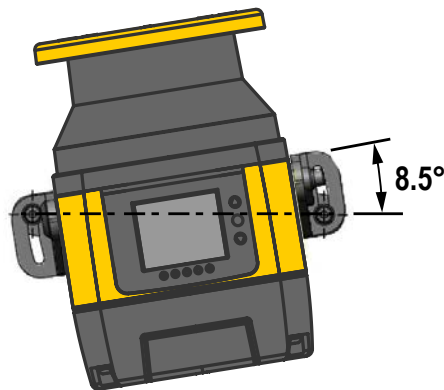

Figure 35. Adjust the roll angle

3.10.6 Scanner Mounting Safety Information

Verify the protection level assured by the SX5 Safety Laser Scanner is compatible with the danger level of the working machine, according to EN ISO 13849-1 or EN 62061.

Dangerous Machine Status:

- Verify the machine is off (not operating) during mounting, electrical installation, and commissioning.
- Verify the safety laser scanner's outputs do not affect the machine during mounting, electrical installation, and commissioning.

- Mounting and connecting the device must be carried out by qualified personnel only, according to the indications included in the specific sections and in the applicable standards.
- Securely install the safety laser scanner so that access to the dangerous zone is not possible without passing throughout the safety area. This must be done according to the indications included in the specific section and in the applicable standards.
- Please carefully read the instructions for the correct functioning before powering the device.

Hazard due to safety device malfunctioning:

- If unsuitable brackets are used, the device may become damaged. Only use approved brackets for mounting.
- Personnel or parts of the body may not be detected in case of non-observance.
- Take appropriate measures for vibration damping if vibration and shock specifications exceed the values and test conditions specified.
- Do not carry out any repairs to the device components.
- Do not open the device components if the document's procedures are not followed.
- The optics cover is an optical component. Verify the optics cover does not become dirty or scratched during mounting.
- Avoid fingerprints on the optics cover.
- Check the integrity of all the components and of all parts.
- If the components show damage, contact the factory.
- Install the device so that the status indicators are clearly visible.
- Observe the minimum safety distances calculated for your machine.
- Install the safety laser scanner so that it is not possible to crawl beneath, climb over, or stand behind the safety area.
- Protect the device from dirt and damage by mounting it in the proper way.
- Do not restrict or obstruct the device's view.
- Correctly align the safety laser scanner even during mounting. If the safety laser scanner is intended to monitor an area of 275° on a corner, the safety laser scanner may be mounted rotated by a maximum of 2.5° about the vertical axis.

4 Electrical Connections



WARNING:

- Make the proper electrical connections
- Connecting equipment to the SX5 other than what is described in this manual could result in serious bodily injury or death.
- Make no more connections to the SX5 than are described in this manual.
- Electrical connections must be made by Qualified Personnel and must comply with NEC (National Electrical Code) and local standards.

Lockout/tagout procedures may be required (refer to OSHA 29CFR1910.147, ANSI Z244-1, or the appropriate standard for controlling hazardous energy). Following relevant electrical standards and wiring codes, such as the NEC, NFPA79 or IEC60204-1, always connect ground (red wire, see wiring diagrams).

All connections are made using the 4-pin M12/Euro-style connector on the front of the unit and 8-pin M12/Euro-style pigtail on the back of the unit. Ensure that the dust cover is re-installed on the 4-pin M12/Euro-style connector when the communication cable is not installed.

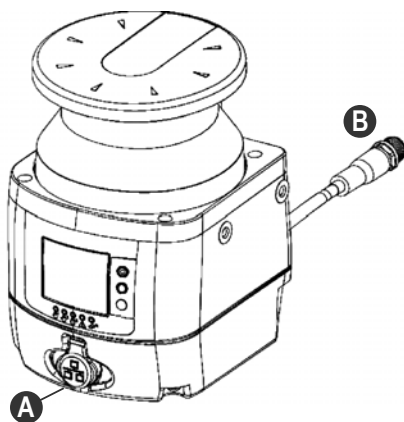

Figure 36. SX5 Safety Laser Scanner

A. M12 4 pole connector on front (for PC Ethernet connection)

B. M12 8 pole pigtail connection in back (for machine interface)

4.1 Routing Cordsets

Connect the SX5 to the machine interface through the 8-pin M12/Euro-style pigtail using color-coded cable wiring according to safety equipment regulations. Banner provides accessory cables with color-coded wiring (referenced in this manual) in compliance with the regulations and standards.

Attach the required cordsets to the SX5 and route the Machine Interface cable (8-pin M12) to the junction box, electrical panel, or other enclosure in which the safety module or other safety related parts of the control system are located. This must be done per local wiring code for low-voltage dc control cables and may require installation of electrical conduit. For information on Banner's accessory cables, see [Accessories](#) on page 87.

Attach the 4-pin M12 ethernet cable if it is to be permanently installed. If the connection is only to be used during configuration (and troubleshooting), route the cable to the PC such that it does not interrupt the scanning field. After the configuration is complete, remove the PC interface cable and replace the dust cover.

The SX5 is designed and manufactured to be highly resistant to electrical noise and to operate reliably in industrial settings. However, extreme electrical noise may cause a random Trip or Latch condition. In extreme cases, a Lockout is possible. SX5 wiring is low voltage; routing the cables alongside power wires, motor/servo wires, or other high voltage wiring may inject noise into the SX5.

It is good wiring practice (and may be required by code) to isolate the SX5 cables from high-voltage wires, avoid routing cables close to noisy wiring, and provide a good earth ground connection to the cordset shield.

4.2 Initial Electrical Connections



Note: The scanner's external power supply must be capable of bridging a brief power failure of 20 ms, as per IEC 60204-1.



Note: A functional earth ground is available on pin 8 of the M12 connector. The user can connect it or leave it floating to achieve in the application a best compliance with electromagnetic interferences.

Ensure that electrical power is not applied to the SX5 until told to do so. Do not connect any wires to the machine control circuits (i.e. OSSD outputs) at this time.

For initial power-up and checkout, connect as described:

- Power connections (pin 2, brown wire, to +24 V dc and pin 7, blue wire, to 0 V dc)
- Reset and Zone Set inputs (pins 3, 4, and 1 (green, yellow, and white wires) depending on configuration and use)

After configuring the SX5 and performing the initial checkout procedure:

- Make the final connection of the OSSD and warning (if used) outputs
- Refer to the installation instructions of any interfacing device (i.e. UM-FA-9A/11A) for proper connection and checkout.

If used, connect the external reset switch to the reset wire of the machine interface cordset and to 24 V dc. See warning about the physical location of the reset switch in [Reset Switch Location](#) on page 32. The reset switch must be a normally open switch that is held closed for approximately 0.5 to 4 seconds, and then re-opened to accomplish the reset. The switch must be capable of switching 10 to 30 V dc at 30 mA.

If used, connect the area switch inputs to the configured pins. This must be done to verify each Zone Set.

4.3 Electrical Connections to the Guarded Machine



CAUTION: Shock Hazard

Always disconnect power from the Banner device and the guarded machine before making any connections or replacing any component. **Use extreme caution to avoid electrical shock at all times.**

Verify that power has been removed from the SX5 and the machine/vehicle to which it will connect. Make the electrical connections described as required by each individual application.

Lockout/tagout procedures may be required (refer to OSHA CFR 1910.147, ANSI Z244-1, or the appropriate standard for controlling hazardous energy). Follow relevant electrical standards and wiring codes, such as the NEC, NFPA79 or IEC 60204-1.

The connections for supply power, external reset (if used) and Zone Set area switch inputs (if used) should already be connected. The SX5 must also have been configured, mounted and passed the initial checkout, as described in [Initial Checkout](#) on page 49.

The final connections to be made are:

- OSSD outputs
- Warning Auxiliary (if used)
- FSD/MPCE Interfacing
- Mute Sensor inputs (if used)
- Mute Enable input (if used)
- Mute Lamp output (if used)
- Override input (if used)

4.3.1 Connecting the OSSD Outputs

Both the output signal switching device (OSSD) outputs must be connected to the machine control so that the machine's safety-related control system interrupts the circuit or power to the machine primary control element(s) (MPCE), resulting in a non-hazardous condition.

Final switching devices (FSDs) typically accomplish this when the OSSDs go to an OFF state. Refer to the output specifications and the warnings below before making OSSD output connections and interfacing the Scanner to the machine.

**WARNING: Interfacing of Both OSSDs**

Both OSSD (Output Signal Switching Device) outputs must be connected to the machine control so that the machine's safety-related control system interrupts the circuit to the machine primary control element(s), resulting in a non-hazardous condition.

Never wire an intermediate device(s) (for example, PLC, PES, or PC) that can fail in such a manner that there is the loss of the safety stop command, OR in such a manner that the safety function can be suspended, overridden, or defeated, unless accomplished with the same or greater degree of safety. **Failure to follow these instructions could result in serious injury or death.**

**WARNING: OSSD Interfacing**

To ensure proper operation, the Banner device output parameters and machine input parameters must be considered when interfacing the Banner device OSSD outputs to machine inputs. Machine control circuitry must be designed so that the maximum load resistance value is not exceeded and that the maximum specified OSSD Off-state voltage does not result in an On condition.

Failure to properly interface the OSSD Outputs to the guarded machine could result in serious injury or death.

4.3.2 Connecting the FSD Interfacing

Final switching devices (FSDs) can take many forms, although the most common are forced-guided, mechanically linked relays or an interface module. The mechanical linkage between the contacts allows the device to be monitored by the external device monitoring circuit for certain failures.

Depending on the application, the use of FSDs can facilitate controlling voltage and current that differs from the OSSD outputs of the SX5. FSDs can also be used to control an additional number of hazards by creating multiple protective stop circuits.

Protective Stop (Safety Stop) Circuits

A protective stop allows for an orderly cessation of motion for safeguarding purposes, which results in the stopping of motion and removal of power from the MPCEs (assuming this does not create additional hazards). A protective stop circuit typically comprises a minimum of two normally open (N.O.) contacts from forced-guided, mechanically linked relays, which are monitored (via external device monitoring) to detect certain failures in order to prevent the loss of the safety function. Such a circuit can be described as a safe switching point.

Typically, protective stop circuits are either single-channel, which is a series connection of at least two N.O. contacts; or dual-channel, which is a separate connection of two N.O. contacts. In either method, the safety function relies on the use of redundant contacts to control a single hazard (if one contact fails ON, the second contact will arrest the hazard and prevent the next cycle from occurring).

The interfacing of the protective stop circuits must be accomplished so that the safety function cannot be suspended, overridden, or defeated, unless accomplished in a manner at the same or greater degree of safety as the machine's safety-related control system that includes the SX5.

The normally open safety outputs from a safety module provide a series connection of redundant contacts that form protective stop circuits for use in either single-channel or dual-channel control.

Dual-Channel Control

Dual-channel control provides the ability to electrically extend the safe switching point beyond the FSD contacts. With proper monitoring, this method of interfacing is capable of detecting certain failures in the control wiring between the safety stop circuit and the MPCEs. These failures include a short circuit of one channel to a secondary source of energy or voltage, or the loss of the switching ability of one of the FSD outputs. Such failures could lead to the loss of redundancy — or to a complete loss of safety, if not detected and corrected.

The possibility of a failure to the wiring increases as the physical distance between the FSD safety stop circuits and the MPCEs increases, as the length or the routing of the interconnecting wires increases, or if the FSD safety stop circuits and the MPCEs are located in different enclosures. For this reason, dual-channel control with EDM monitoring should be used in any installation where the FSDs are located remotely from the MPCEs.

Single-Channel Control

Single-channel control uses a series connection of FSD contacts to form a safe switching point. After this point in the machine's safety-related control system, failures can occur that would result in the loss of the safety function (such as a short-circuit to a secondary source of energy or voltage).

For this reason, single-channel control interfacing should be used only in installations where FSD safety stop circuits and the MPCEs are mounted within the same control panel, adjacent to each other, and are directly connected to each other; or where the possibility of such a failure can be excluded. If this cannot be achieved, then dual-channel control should be used.

Methods to exclude the possibility of these failures include, but are not limited to:

- Physically separating interconnecting control wires from each other and from secondary sources of power.
- Routing interconnecting control wires in separate conduit, runs, or channels.
- Locating all elements (modules, switches, and devices under control) within one control panel, adjacent to each other, and directly connected with short wires.
- Properly installing multi-conductor cabling and multiple wires through strain relief fittings. (Over-tightening of a strain-relief can cause short-circuits at that point.)
- Using positive-opening or direct-drive components, installed and mounted in a positive mode.

4.3.3 Machine Primary Control Elements and External Device Monitoring

A machine primary control element (MPCE) is an "electrically powered element that directly controls the normal operation of a machine in such a way that it is the last element (in time) to function when machine operation is to be initiated or arrested" (per IEC61496-1). Examples include motor contactors, clutch/brakes, valves, and solenoids.

Depending on the level of risk of harm, it may be required to provide redundant MPCEs or other control devices that are capable of immediately stopping the dangerous machine motion, irrespective of the state of the other. These two machine control channels need not be identical (they could also be diverse redundant), but the stop time performance of the machine (T_s , used to calculate the safety distance, see [Minimum Safety \(Separation\) Distance Formula](#) on page 30) must take into account the slower of the two channels. See [Wiring Diagrams](#) on page 46

To ensure that an accumulation of failures does not compromise the redundant control scheme (i.e., cause a failure to danger) a method to verify the normal functioning of MPCEs or other control devices is required. The Scanner provides this function only when configured for manual start/restart (reset) with MPCE monitoring contacts wired in series with the reset (start/restart) switch as shown in [Wiring Diagrams](#) on page 46 (see also [Reset Switch Location](#) on page 32).

When the SX5 is configured for Automatic Start/Restart (Reset), to properly monitor the MPCEs an External Device Monitoring (EDM) function must be provided by an external means from the Scanner. One example using the UM-FA-9A/-11A safety Module is shown in [Wiring Diagrams](#) on page 46. The UM-FA-9A/-11A can be configured for both manual or automatic reset and provide the required EDM function.

For external device monitoring to function properly, each device must include a normally closed (N.C.), forced-guided (mechanically linked) contact that can accurately reflect the status of the device. This ensures that the normally open contacts, used for controlling hazardous motion, have a positive relationship with the normally closed monitoring contacts and can detect a failure to danger (e.g., contacts that welded closed or stuck ON).

It is strongly recommended that a normally closed, forced-guided monitoring contact of each FSD and MPCE be connected to EDM inputs (see [Wiring Diagrams](#) on page 46). If this is done, proper operation will be verified. Monitoring FSD and MPCE contacts is one method of maintaining control reliability (OSHA/ANSI) and Category 3 and 4 (ISO13849-1).

If monitoring contacts are not available or do not meet the design requirement of being forced-guided (mechanically linked), it is recommended to:

- Replace the devices so that they are capable of being monitored, or
- Incorporate the EDM function into the circuit as close to the MPCE as possible (e.g., monitor the FSDs), and
- Employ use of well-trying, tested, and robust components, and generally accepted safety principles, including fault exclusion, into the design and installation to either eliminate, or reduce to an acceptable (minimal) level of risk, the possibility of undetected faults or failures that can result in the loss of the safety function.

The principle of fault exclusion allows the designer to design out the possibility of various failures and justify it through the risk assessment process to meet the required level of safety performance, such as the requirements of Category 2, 3 or 4. See ISO 13849-1/-2 for further information.



WARNING:

- Notice Regarding MPCEs
- Failure to follow these instructions could result in serious injury or death.
- Each of the machine primary control elements (MPCE1 and MPCE2) must be capable of immediately stopping the dangerous machine motion, regardless of the state of the other. The two machine control channels need not be identical, but the machine's stop time performance (T_s , used to calculate separation distance) must be based on the slower of the two channels.



WARNING: EDM Monitoring. If the System is configured for “No Monitoring,” it is the user’s responsibility to ensure that this does not create a hazardous situation. **Failure to follow these instructions could result in serious injury or death.**

4.3.4 Warning (Auxiliary) Output

The scanner can have pins 1, 3, or 4 set as a Warning Output(s). One warning output can be selected when one or two zone sets are configured. Two warning outputs can be selected when one zone set with one safety zone and two warning zones is configured. These outputs provide a PNP current-sourcing output (250 mA maximum) that switches ON when the defined and active warning field is cleared and switches OFF when the active warning field is interrupted.

4.3.5 Preparing for System Operation

After the initial trip test has been performed (see [Perform a Trip Test](#) on page 50), and the OSSD safety output connections have been made to the machine to be controlled, the SX5 is ready for testing in combination with the guarded machine.

The operation of the SX5 with the guarded machine must be verified before the combined SX5 and machine may be put into service. To do this, a Qualified Person must perform the Commissioning Checkout Procedure described in [Checkout Procedures](#) on page 78.

4.3.6 Machine Interface Connections

The SX5 Safety Laser Scanner model has one OSSD pair and includes three configuration signals.

These signals allow the user to configure the scanner with different functions:

- Signaling when a person or an object is in a Warning Zone
- Switching the detection areas using external signals (Area Switch)
- Restarting the device using a Manual reset (restart) and restoring the device after a fault condition (reset)
- Muting the whole safety area and the single line pattern mute dependent override

Type	Signal	Color	Description	Pin
Power	Power supply	Brown	24 V dc	2
	GND_ISO	Blue	0 V	7
Input/Output	Multi in/out	Green	Software selectable	3
		Yellow		4
		White		1
Safety output	OSSD 1/1	Gray	Safety output	5
	OSSD 1/2	Pink		6
Other	F_EARTH	Red	Functional Earth	8

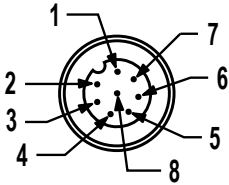

The Multi in/out pins can be configured either as an input or an output.

Signal	Function	Connection
Multi In	Restart/Reset	
	Area switch	
	Override (single line pattern)	
	Muting 1 Muting 2	
	Muting Enable	
Multi Out	Warning	

Signal	Function	Connection
	Muting Lamp	
OSSD	OSSD 1/1 OSSD 1/2	

4.3.7 Wiring Diagrams

Wiring with FSD Inputs

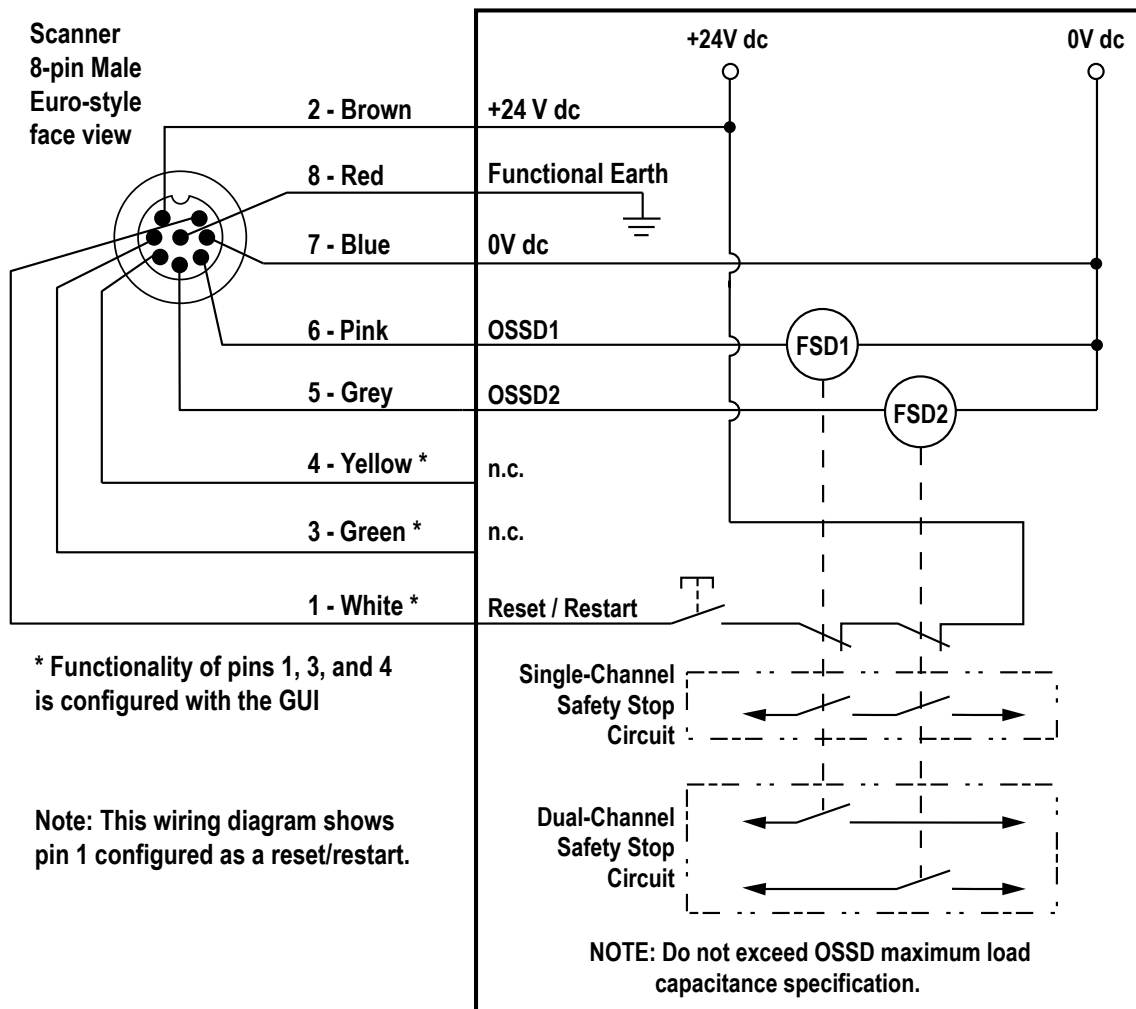

Figure 37. Wiring with FSD inputs

Monitoring FSDs—FSDs must be monitored for proper operation. One-channel EDM can only be used when the scanner is configured for manual reset.

Wiring Using a UM Module

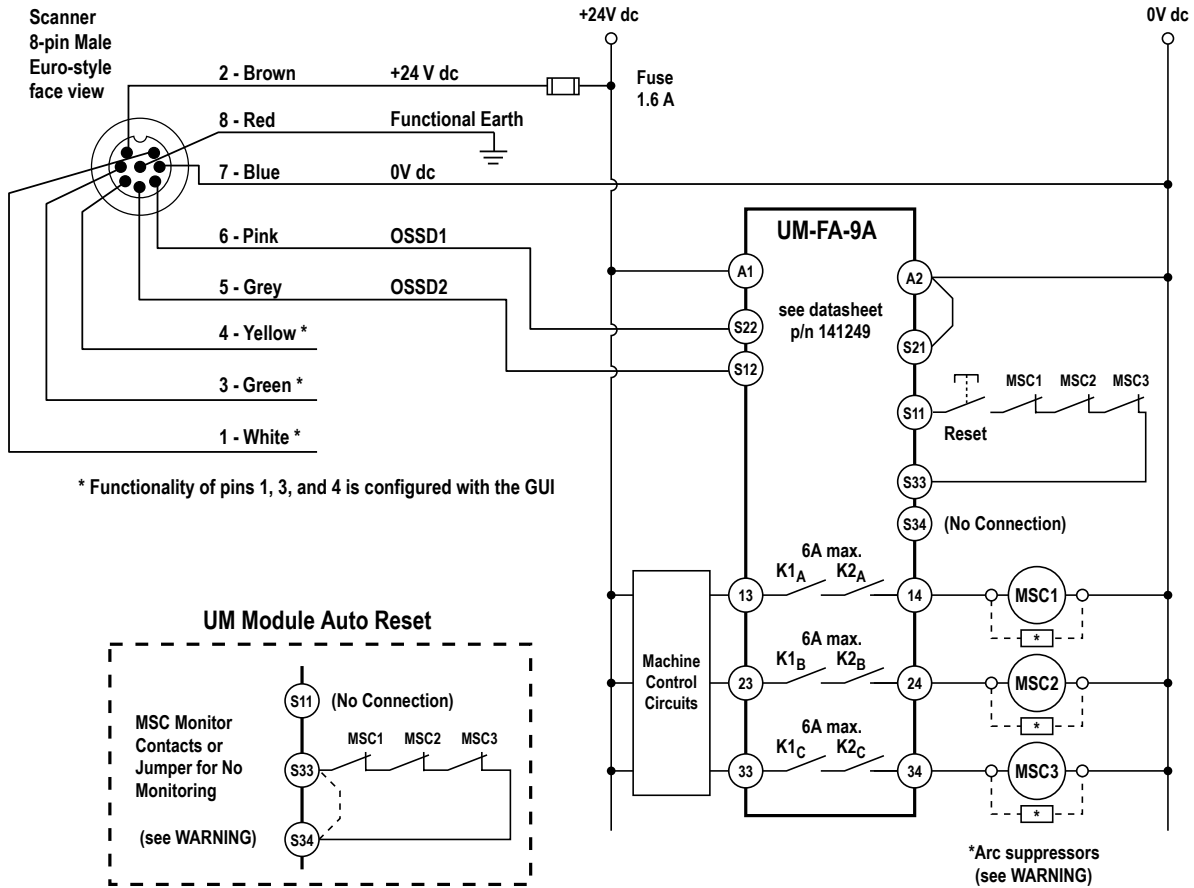

Figure 38. Wiring using a UM module

Wiring to a Safety Controller

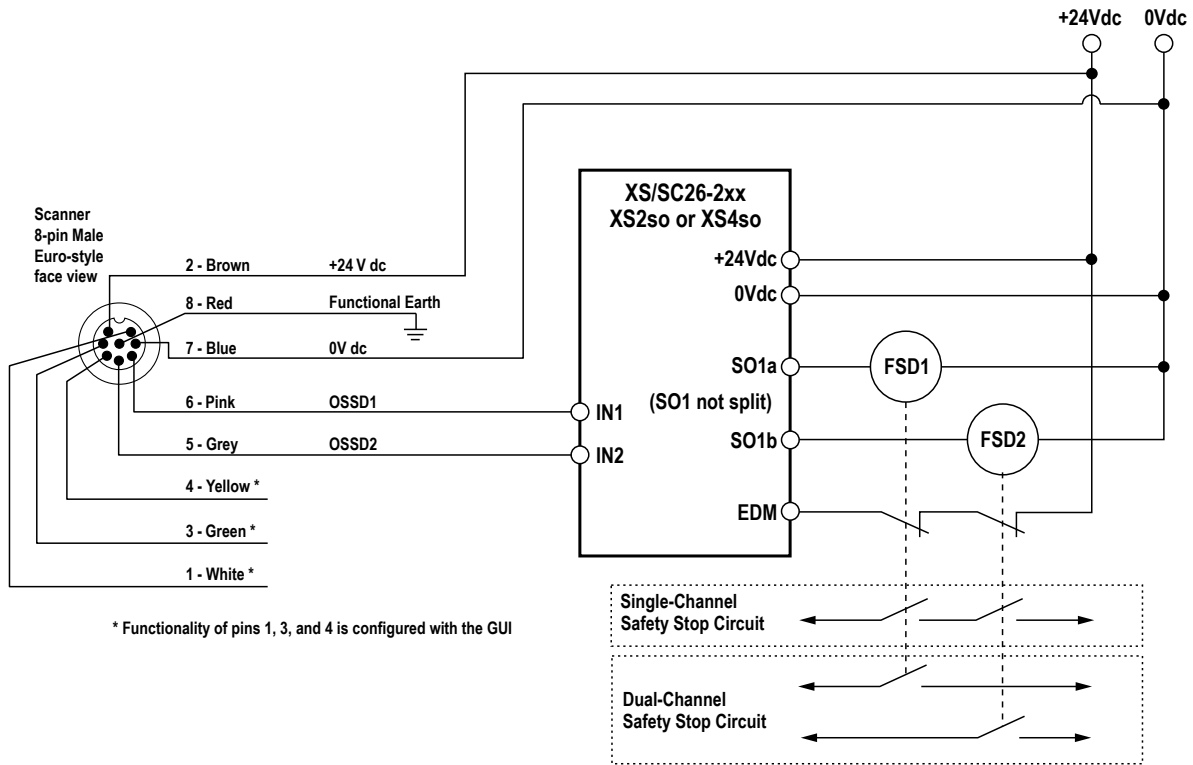

Figure 39. Wiring to a Safety Controller

5 Initial Checkout

The initial checkout procedure must be performed by a Qualified Person, and must be performed only after configuring the System and after connections are made.

Initial checkout is performed on two occasions:

1. To ensure proper installation when the System is first installed, and
2. To ensure proper System function whenever any maintenance or modification is performed on the System or on the machinery being guarded by the System.

For the initial checkout, the SX5 must be checked without power being available to the guarded machine.

Final interface connections to the guarded machine cannot take place until the SX5 has been checked out. This may require lockout/tagout procedures (refer to OSHA1910.147, ANSI Z244-1, or the appropriate standard for controlling hazardous energy). These connections will be made after the initial checkout procedure has been successfully completed.

5.1 Apply Initial Power and Configure the Scanner

Verify:

- Power has been removed from (or is not available to) the guarded machine, its controls, or actuators;
- The machine control circuit or the safety module is not connected to the OSSD outputs at this time (permanent connections will be made later);
- The ethernet cable (4-pin M12/Euro-style to RJ45 cable) is connected to the SX5's 4-pin connector on the front of the unit (if not previously accomplished) and connect the RJ45 to the PC ethernet port.



1. On the computer, launch the SX5soft software.
2. Apply power to the SX5.
3. If not previously completed, configure the scanner as described in [Configuration Instructions](#) on page 53.

The scanner must be powered off during any connection operation. During configuration, the scanner will be working using its previously saved configuration. Follow all the safety instructions.

4. Optional: Status information can be uploaded (Monitoring) or you can download the configuration to the scanner (Programming).

5.2 Verify the Optical Field (Initial Verification)

The following is the typical display indication, assuming a Warning Zone is configured.

Status	OSSD Output	Warning Aux Output	
Safety and Warning Zones clear	On	On	
Safety Zone clear, Warning Zone interrupted	On	Off	
Safety and Warning Zones interrupted	Off	Off	

Status	OSSD Output	Warning Aux Output	
Warning and Safety Zone is clear, waiting for reset	Off	On	

1. Inspect nearby areas for lights and retro-reflective surfaces.
 - If found, attempt to remove, cover, or otherwise prevent the item from being located in the scanner's detection plane.
 - If you are unable to do this, ensure the appropriate distance has been added to the separation distance (see Z_{amb} light factors in *Minimum Safety (Separation) Distance Formula* on page 30).
2. Inspect the installation for unmonitored areas and adjacent scanners.
3. In Run mode, observe the scanner's status display to determine status. If any other indication is shown on the display, see *Diagnostic Notes, Warnings, and Errors* on page 83.
4. Ensure that the scanner is in the Run mode, the Safety and Warning Zones are clear of intrusions, and the scanner's display shows the Zones are clear (or clear and waiting for a reset).
5. Perform a Trip Test to verify the Safety and Warning Zones.

5.3 Perform a Trip Test

Performing a trip test verifies the Safety and Warning Zone fields.



CAUTION: Ensure that no individuals are exposed to any hazard while verifying the Safety and Warning Zones.



Note: Although the GUI can assist in monitoring the position of objects and the status of the Safety and Warning Zones, use the display, when possible, to determine whether or not a zone has been interrupted.

1. Ensure that the SX5 is in Run mode, the Safety and Warning Zones are clear of intrusions, and the display shows one of the following:



Zones are clear; OSSDs are on



Zones are clear; waiting for a reset input

2. If a Warning Zone is used and with the guarded machine at rest:
 - a) Use a 70 or 40 mm (based on resolution selected in configuration) test piece to interrupt the Warning Zone perimeter.
 - b) Verify the display shows the yellow warning indication.
 - c) Remove the test piece and verify the warning indicator returns to the status shown in step 1.
 - d) Repeat this test along the entire Warning Zone perimeter, paying special attention to needle- and cone-shaped areas.



Yellow warning indication

- Use the test piece to interrupt the perimeter of the Safety Zone.



The display when a test piece interrupts the Safety Zone

- Remove the test piece and verify the display returns to the green Go display shown in step 1.
- Repeat this test along the entire Safety Zone perimeter and verify that the configured zone:
 - Responds to the intrusion of the test piece.
 - Has no unmonitored areas as described in [Unmonitored Areas](#) on page 23.
 - Complies with the Safety Distance calculated in [Minimum Safety \(Separation\) Distance Formula](#) on page 30.

Pay special attention at needle- and cone-shaped areas.

- For stationary applications, verify that the marking of the perimeter of the Safety Zone on the floor corresponds with the status of the display. If the floor has not been marked, do so now, with the aid of the display response.
- Verify the height of the Safety Zone at the perimeter is at the expected level (for example, 150 mm for mobile applications):
 - Safety Zones of 180° to 275°—Verify the height in at least four locations, approximately 90° apart from each other.
 - Safety Zones of 90° to 180°—Verify the height in at least three locations, approximately 90° apart from each other.
 - Safety Zones of 90° or less—Verify the height in at least two locations, approximately 90° apart from each other.

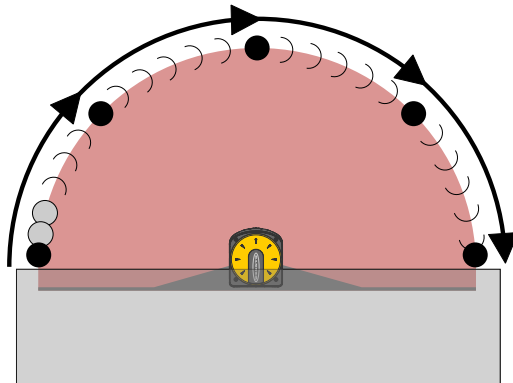

Figure 40. Safety Zone angles and locations for verification

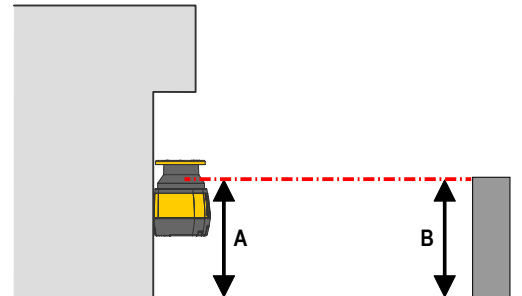

Figure 41. Safety Zone height

- If Zone Set switchover is used, repeat steps 1 through 7 for each Zone Set that has been configured. Ensure all fields correspond to the expected fields as determined by the risk assessment. **If not, do not continue until the situation is corrected.**
- After all corrections and changes to the configuration and the Safety and Warning Zones have been verified, proceed to Electrical Interface to the Guarded Machine.



WARNING: If the Trip Test Indicates a Problem

If the SX5 System does not respond properly to the trip test, do not attempt to use the System. If this occurs, the System cannot be relied on to stop dangerous machine motion when a person or object enters the sensing field. **Failure to follow these instructions could result in serious injury or death.**

Other checks to carry out include:

- Performing system checkouts to ensure the continued reliable operation. Banner Engineering highly recommends performing the system checkouts as described in the checkout procedures. However, a Qualified Person should evaluate these recommendations, based on the specific application and the results of a machine risk assessment, to determine the appropriate content and frequency of checkouts.
- Designing the Safety Zone so that the approach towards any dangerous point of the machine can only be accessed by passing through the Safety Zone, and the distance that a person has to cover must be longer than the minimum safety distance.

- Ensuring a person is unable to remain between the Safety Zone and the dangerous parts of the machine undetected.
- Ensuring access to the dangerous areas of the machine is not possible from any unprotected area.
- Documenting safety checks in a traceable manner.
- Immediately shutting down the machine if the safety check session reveals hypothetical faults. The electrical and mechanical installation must be checked for further verifications by qualified personnel.

6 Configuration Instructions

6.1 System Configuration Settings

The Scanner must be configured by the user to satisfy the requirements of your application.

Use the SX5's configuration software to establish the SX5 operating parameters. Download the SX5soft software from www.bannerengineering.com.

The software is the SX5's configuration tool, providing several important advantages:

- Intuitive Graphical User Interface for rapid configuration
- Defined configuration directly stored in the device
- Discovery and IP address setting features to facilitate remote configuration
- Device Monitoring

The software can be used with a SX5 connected or offline (without a SX5). A configuration can be saved and downloaded to a SX5 at a later time.

6.1.1 Response Time and Scan Cycle Setting

The response time of the scanner is the time from when an object enters the Safety Zone to when the OSSD goes to the OFF state. The scanner scans cyclically with a constant speed and it requires 30 ms to complete one rotation.

The minimum response time of the scanner is 62 ms, which is the time needed by the scanner to make two rotations (scans).

Select the number of scans (and therefore the response time) using the configuration software. The user may enter response times from 62 to 482 ms in 30 ms increments (by changing the number of scans from 2 to 16).

Increase the number of scans if the scanner is operating in a dirty environment caused by floating dust particles (here the user may need to collect more data, experiment, to prevent inadvertent OSSD off signals from dust).



CAUTION: If the application requires changing the response time, the configuration may require changes to the Safety Zone (making it bigger) or changes in the scanner installation.

Default setting: 62 ms.

6.1.2 Automatic or Manual Start/Restart

Depending on the number of zone sets being used in the configuration, the Qualified Person can select an Automatic Start/Restart (trip output) or a Manual Start/Restart (latch output). This setting determines if the SX5 enters Run mode automatically or if a manual reset is required first.

Select automatic or manual start/restart using the configuration software.

If Automatic Start/Restart is selected, the OSSD outputs turn on after power is applied, and the SX5 passes its internal self-test and recognizes that the Safety Zone is clear. The OSSD outputs also turn on after the Safety zone clears following a blockage. When the SX5 is set for Automatic Start/Restart, other measures must be taken to prevent a pass-through hazard.

For mobile applications, BS/DIN EN 1525 requires a two (2) second restart delay after the Safety Zone becomes clear before the OSSDs turn back on. This delay is meant to allow an individual to fully clear the area protected by the scanner. For mobile applications, set the Recovery Time for at least 2000 ms.

If Manual Start/Restart is selected, the SX5 requires a manual reset for the OSSD outputs to turn on when power is applied and the safety zone is clear. The manual Restart switch must be pressed for at least 500 ms.



WARNING: Use of Auto (Trip) or Manual (Latch) Start/Restart

Application of power to the Banner device, the clearing of the sensing field, or the reset of a manual start/restart (latch) condition **MUST NOT** initiate dangerous machine motion. Machine control circuitry must be designed so that one or more initiation devices must be engaged (in a conscious act) to start the machine – in addition to the Banner device going into Run mode. **Failure to follow these instructions could result in serious injury or death.**

**WARNING:**

- **Start/Restart (Reset) Switch Location**
- Failure to follow these instructions could result in serious injury or death.
- The system Start/Restart (Reset) switch must be accessible only from outside, and in full view of, the hazardous area. Reset switches must also be out of reach from within the safeguarded space, and must be protected against unauthorized or inadvertent operation (via rings, guards, key or other means). If any areas are not visible from the reset switch, additional means of safeguarding must be provided.

6.2 Muting Functions

To mute the primary safeguard appropriately, the design of a muting system must:

- Identify the non-hazardous portion of the machine cycle.
- Select the proper muting devices.
- Include proper mounting and installation of those devices.

The SX5 Safety Laser Scanner is equipped with Integral Muting that can monitor and respond to redundant signals that initiate the mute. The mute automatically suspends the safeguarding function to allow an object to pass through the Safety Zone, without generating a stop command.

The mute may be triggered by a variety of external devices. This feature provides a variety of options to tailor the system to the requirements of a specific application. A pair of muting devices must be triggered within time selected in the configuration (the maximum delay between the activation of mute 1 and mute 2 can be set for 1 second to 16 seconds, with the default time being 4 seconds) of each other, but the order does not matter. The mute sensors cannot activate simultaneously. This reduces the chance of common mode failures or defeat.



WARNING: Muting Limitations— Muting is allowed only during the non-hazardous portion of the machine cycle (ISO 13849-1 and ANSI B11.19). Muting at power up cannot be configured in this scanner.

**WARNING:**

- **Muting Inputs Must Be Redundant**
- Failure to follow these instructions could result in serious injury or death.
- Do not use a single switch, device, or relay with two N.O. contacts for the mute inputs. A single device, with multiple outputs, may fail so that the system is muted at an inappropriate time. This could result in a hazardous situation.

6.2.1 Mute Devices

The beginning and end of a mute cycle must be triggered by outputs from the muting devices, depending on the application.

The mute devices must either have normally open contacts or have PNP outputs, both of which fulfill the muting device requirements. These contacts must close (conduct) when the switch is actuated to initiate the mute and must open (non-conducting) when the switch is not actuated or in a power OFF condition.

The SX5 Safety Laser Scanner with Integral Muting monitors the mute devices to verify that their outputs turn on within the selected time of each other (order does not matter). If the inputs do not meet this simultaneity requirement, a mute condition will not occur.

The mute devices should be powered from the same power supply powering the scanner. Several types and combinations of mute devices can be used, including but not limited to: limit switches, photoelectric sensors, positive-driven switches, inductive proximity sensors, and 'whisker' switches.

6.2.2 Mute Device Requirements

The muting devices must, at a minimum, comply with the following requirements:

1. There must be a minimum of two independent hard-wired muting devices.
2. The muting devices must have one of the following: normally open contacts, PNP outputs (both of which must fulfill the input requirements listed in the Specifications), or a complementary switching action. At least one of these contacts must close when the switch is actuated, and must open (or not conduct) when the switch is not actuated or is in a power-off state.

3. The activation of the inputs to the muting function must come from separate sources. These sources must be mounted separately to prevent an unsafe muting condition resulting from misadjustment, misalignment, or a single common mode failure, such as physical damage to the mounting surface. Only one of these sources may pass through, or be affected by, a PLC or a similar device.
4. The muting devices must be installed so that they cannot be easily defeated or bypassed.
5. The muting devices must be mounted so that their physical position and alignment cannot be easily changed.
6. It must not be possible for environmental conditions, such as extreme airborne contamination, to initiate a mute condition.
7. The muting devices must not be set to use any delay or other timing functions unless such functions are accomplished so that no single component failure prevents the removal of the hazard, subsequent machine cycles are prevented until the failure is corrected, and no hazard is created by extending the muted period.

6.2.3 Examples of Muting Sensors and Switches

Photoelectric Sensors (Opposed Mode)

Opposed-mode sensors, which initiate the muted condition when the beam path is blocked, should be configured for dark operate (DO) and have open (non-conducting) output contacts in a power OFF condition. Both the emitter and receiver from each pair should be powered from the same source, to eliminate common mode failures.

Photoelectric Sensors (Polarized Retroreflective Mode)

The user must ensure that false "proxing" (activation due to shiny or reflective surfaces) is not possible. Banner "LP" sensors with linear polarization can greatly reduce or eliminate this effect.

Use a sensor configured for Light Operate (LO or N.O.) if initiating a mute when the retroreflective target or tape is detected (e.g., home position). Use a sensor configured for Dark Operate (DO or N.C.) when a blocked beam path initiates the muted condition (e.g., entry/exit). Both situations must have open (non-conducting) output contacts in a power OFF condition.

Positive-Opening Safety Switches

Two (or four) independent switches, each with a minimum of one closed safety contact to initiate the mute cycle, are typically used. *An application using a single switch with a single actuator and two closed contacts could result in an unsafe situation.*

Inductive Proximity Sensors

Typically, inductive proximity sensors are used to initiate a muted cycle when a metal surface is detected. Due to excessive leakage current causing false ON conditions, two-wire sensors are not to be used. Only three- or four-wire sensors that have discrete PNP or hard-contact outputs that are separate from the input power can be used.



Note: Typical Entry/Exit is Dark Operate (DO) with through-beam or polarized retroreflective sensors. Typical Home Position and Power Press applications are Light Operate (LO) or "closed switch to mute".



WARNING: Avoid Hazardous Installations

Two or four independent position switches must be properly adjusted or positioned so that they close only after the hazard no longer exists, and open again when the cycle is complete or the hazard is again present. If the switches are improperly adjusted or positioned, injury or death may result.

The user is responsible to satisfy all local, state, and national laws, rules, codes, and regulations relating to the use of safety equipment in any particular application. Make sure that all appropriate agency requirements have been met and that all installation and maintenance instructions contained in the appropriate manuals are followed.

6.2.4 Mute Enable (ME)

The Mute Enable function allows the user control of the state of a mute condition.

Select Mute Enable 1 for one of the input signals (pins 1, 3, or 4) on the Input Configuration page of the SX5soft software.

- To enable a mute condition, pull the Mute Enable 1 pin high (+24 V dc)
- To disable a mute condition, connect the Mute Enable 1 pin to dc common (0 V dc) or leave it open

The +24 V dc and 0 V dc should come from the same power supply as the SX5.

Typical uses for Mute Enable include:

1. Allowing the machine control logic to create a 'window' for muting to begin

2. Inhibiting muting from occurring
3. Reducing the chance of unauthorized or unintended bypassing or defeating of the safety system

6.2.5 Mute Lamp Output

The SX5's display provides a visible indication that the safety device's safeguarding function is muted.

Under **Output Configuration**, select a Muting Lamp output. Configure one of the Output Signals (pins 1, 3, or 4) as Muting Lamp 1. The Muting Lamp 1 line will pulse on and off +24 V dc when the system is muted.



CAUTION:

- **Mute Status Must Be Readily Observable**
- Failure to follow these instructions could result in serious injury or death.
- Indication that the safety device is muted should be provided and be readily observable. Failure of this indication should be detectable and prevent the next mute, or the operation of the indicator should be verified at suitable intervals.

6.2.6 Mute Time Limit (Backdoor Timer)

The Mute Time Limit (Backdoor Timer) allows the user to select a maximum period of time that muting is allowed to occur. The Mute Time Limit can be set between 10 and 1080 minutes in 1 minute increments using SX5soft.

The timer begins when the second muting device makes the simultaneity requirement and allows a mute to continue for the predetermined time. After the timer expires, the mute ends no matter what the signals from the mute devices indicate. An Override can be performed to clear the obstruction (if configured). For no time limit (infinite time), select a time of 0 minutes.

Factory default setting: 10 minutes



WARNING:

- **Selecting the Muting Time Limit (Backdoor Timer)**
- It is the user's responsibility to ensure the Mute Time Limit (Backdoor Timer) setting does not create a hazardous situation.
- Select an infinite time for the backdoor timer (disabling) only if the possibility of an inappropriate or unintended mute cycle is minimized, as determined and allowed by the machine's risk assessment.

6.2.7 Mute-Dependent Override

Overriding a safeguarding device is the manual interruption or suspension of the normal function of a safeguard under supervisor control. Typically, an Override is needed to clear an object that is stuck within the SX5's Safety Zone, such as in an entry/exit application.

Overriding a safeguarding device should not be confused with muting, which is the temporary, automatic suspension of the safeguarding function of a safeguarding device during a non-hazardous portion of the machine cycle. Muting allows for material to be manually or automatically fed into a machine or process without issuing a stop command.

When Override (or Bypass) is used, the following precautions must be taken:

- Prevent exposure to any hazards during an Override; supplemental safeguarding must be provided per ANSI B11.19, ANSI/NFPA 79, IEC/EN 60204-1, and ISO 13849-1.
- The means of overriding and visual indication must be provided and be readily observable from the location of the safeguard.
- The reset, actuation, clearing, or enabling of the safeguarding device must not initiate hazardous motion or create a hazardous situation.
- Standards require the use of spring return, hold-to-run, device or secure momentary action push buttons, located so that it will not be possible to enter the hazardous zone while maintaining the state of the devices.

The Override switch must be supervised and must prevent automatic operation. This function requires one normally closed switch connecting +24 V dc to Override 1 1 configured input (pin 1, 3, or 4) and one momentary machine start switch. Also, one or more of the following must be true:

- Motion should be initiated by a hold-to-run or similar device
- If a portable control station (e.g. an enabling device) with an emergency stop device is used, motion may be initiated only from that station/device. All emergency stops must remain active.
- Automatic machine operation must be prevented by limiting range of motion, speed, or power (e.g. only used in inch, jog, or slow speed modes).

Mute-Dependent Override function allows the user to manually force the OSSD outputs on for up to the configured maximum override time (120 seconds). To initiate an override, the scanner's Safety Zone must be violated with the OSSD outputs off and at least one mute device must be blocked (on). If this condition is true, the display shows the OVERRIDE warning and the OSSD LED is green. The override function automatically terminates when one of the following happens:

- All the mute sensor inputs are de-actuated (switched to the off state) (in a bidirectional-muting configuration)
- The 120 second maximum override time limit has expired
- The override switch opens (is released)
- All the muting sensors are de-actuated and no beams of the Safety Zone are interrupted (in a unidirectional-muting configuration)

The SX5's outputs stay on at the end of the override sequence (assuming the SX5's Safety Zone is clear, and it is configured for Automatic Restart).

6.2.8 Muting Function T (X) (Bidirectional) or L (Unidirectional) Selection

The SX5 has multiple muting configurations. The SX5 can monitor and respond to muting sensors in the Bidirectional or Unidirectional configuration. Configure the directional setting of the muting on the **Input Configuration** screen.

Factory default setting: Bidirectional

Use the X configuration when the SX5 is mounted vertically and Bidirectional is selected in the configuration. The X configuration uses two muting sensors (e.g. two pairs of opposed-mode photoelectric sensors as shown below). The crossing point of the two sensing paths must be on the hazardous side of the Safety Zone.

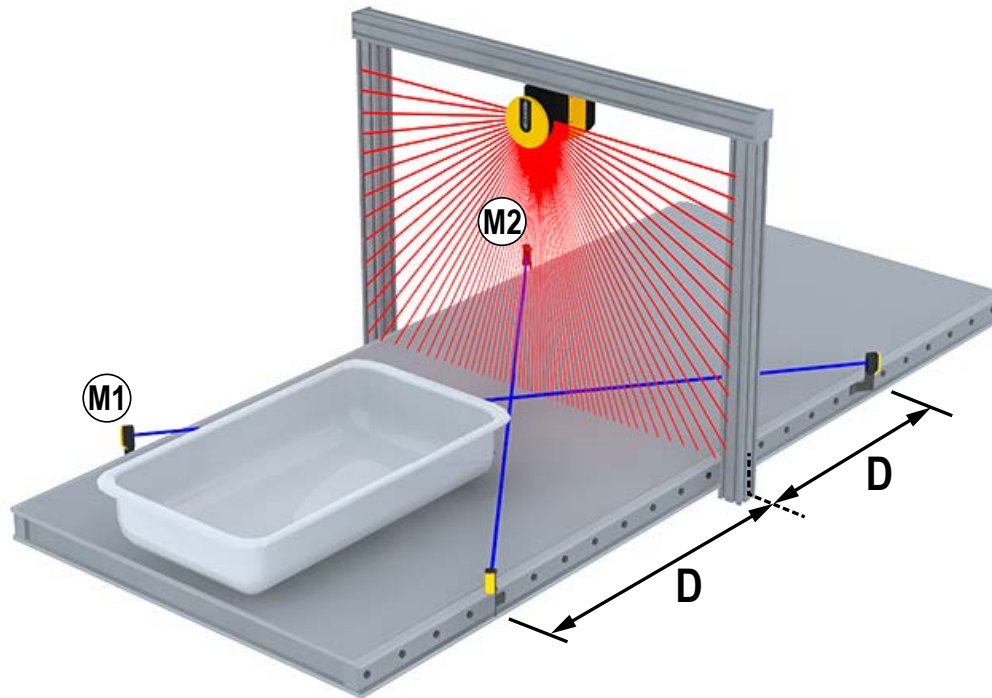

Figure 42. Muting function in the X configuration

Use the T configuration when the SX5 is mounted vertically and Bidirectional is selected in the configuration. The T configuration uses four muting sensors. For example, four pairs of opposed-mode or retro-reflective photoelectric sensors or diffuse photoelectric sensors with background elimination, spaced with two on the inside and two on the outside of the Safety Zone.

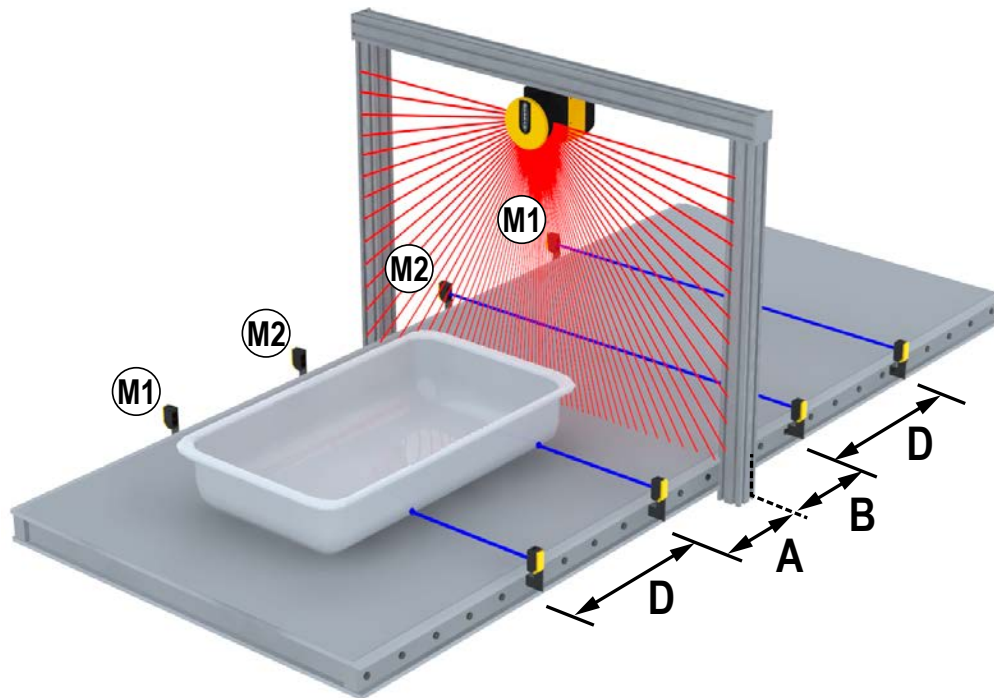

Figure 43. Muting function in the T configuration

Use the L configuration when the SX5 is mounted vertically and Unidirectional is selected in the configuration. This configuration is suitable for applications requiring unidirectional movement of objects. This configuration uses two mute sensors (e.g. two pairs of opposed-mode photoelectric sensors) stationed on one side of the Safety Zone. The muting is initiated when the two sensors are made within the configured time of each other in the proper order (mute 1, then mute 2). The mute cycle ends when the configured time limit is reached after the first mute sensor clears.

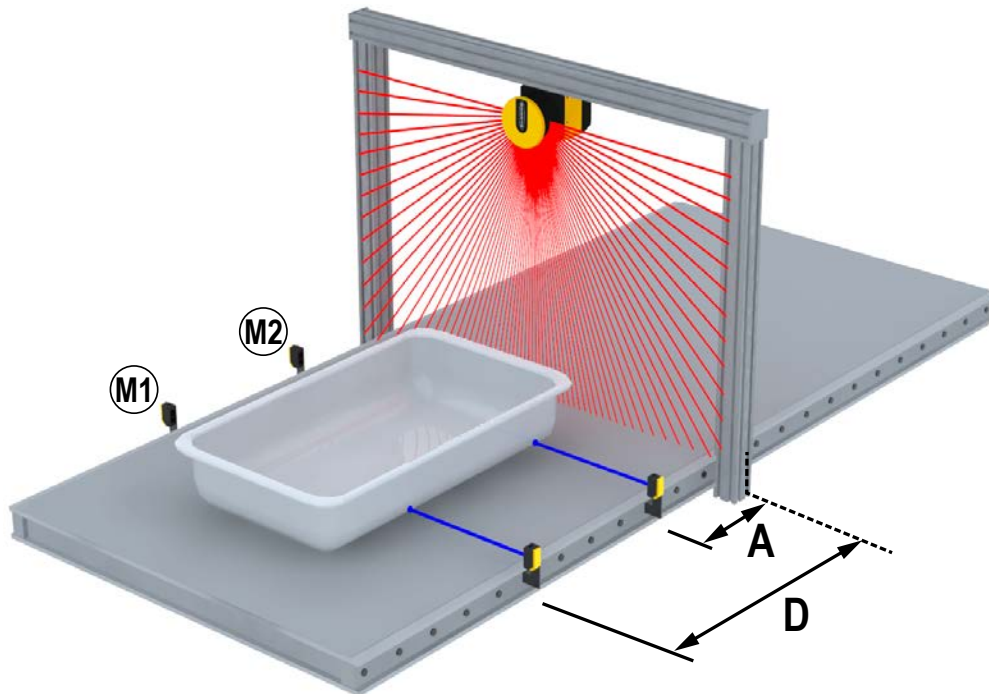

Figure 44. Muting function in the L configuration



CAUTION: Unidirectional muting should only be used for removing materials from the dangerous area.

6.3 Install the SX5soft Software

The SX5 Safety Laser Scanner is not required to install SX5soft on a PC. If the PC and SX5 are already connected, turn the power off to the SX5.

Before installing SX5soft, close all Windows applications.

1. Download SX5soft from www.bannerengineering.com (search for SX5 and look under Downloads).
2. Double-click on SetupSX5soft. This file is probably in your Downloads directory. The installation wizard starts.
3. Click **Next**.
The installation wizard opens the software license agreement.
4. To accept the software license contract, click **I Accept**, then click **Next**.
5. To accept the recommended installation path, click **Next**. To enter another path, click **Browse** and select the desired path.
6. Click **Install**.
The installation process begins.
7. Click **Finish**.
The installation process completes.

6.4 Software Interface

In addition to being able to display a graphic rendering of the monitored area, the software provides configuration and management tools, including file title header, drop-down menus, function-specific worksheets which contain entries relevant to specific portions of the configuration.

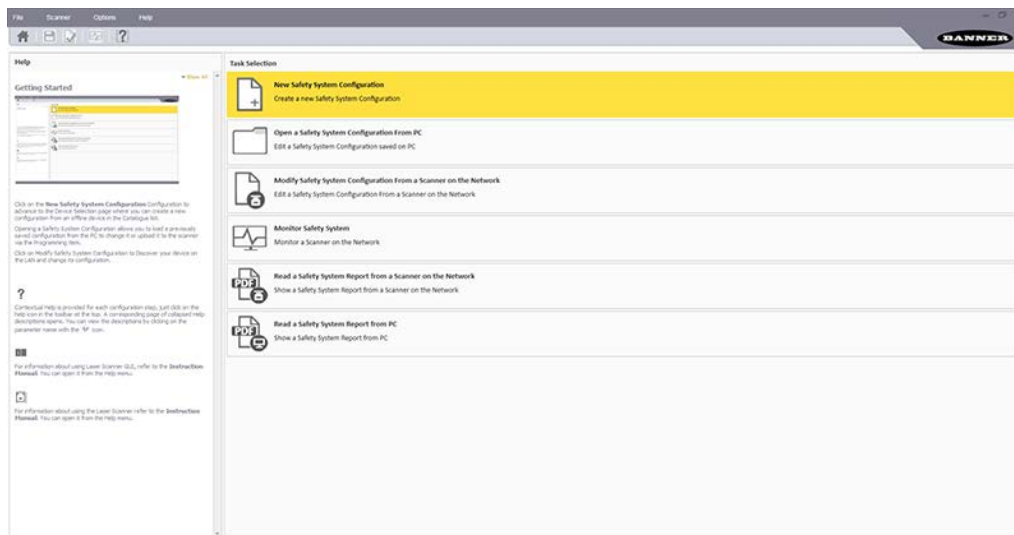

Figure 45. SX5soft

Menu Bar and Toolbar—Contains the SX5soft main features.

Task Selection—Presents a list of the task that can be performed from SX5soft. These selections are also available in the **File** and **Scanner** menus.

Status Bar—Located at the bottom of the screen, the status bar displays specific information about connected devices (once discovered). It displays information on the current network status, the connected device status, the connector, and the application type.

Help Online—Includes all the information and parameters to create a proper configuration. For the next configuration steps, the help online is available only by clicking on the dedicated button.

6.4.1 Main Menu

The following menu options are available.

File

- New Configuration—Creates a new device configuration from scratch.
- Open Configuration from PC—Opens a previously saved Configuration file.
- Read from PC - Report—Shows a Safety System Configuration Report saved on the PC.
- Save—Saves the current configuration or report to PC.
- Exit—Exits SX5soft user interface.

Scanner

- Discovery—Searches for a scanner connected to the Network (LAN).
- Open Configuration from device—Opens the configuration already loaded on a scanner.
- Apply Configuration—Transfers a configuration to a connected scanner.
- Read from Device - Report—Shows a Safety System Configuration Report for Scanner's configuration.
- Settings—Change Network Configuration, Change Access Controls, Reset Password.
- Update Firmware—Updates the firmware file of the scanner.





Options

- Change Language—Allows the user to change the display language used in SX5soft in real time. The selected language will also be used for successive sessions.
- Change GUI Log Level—Verbose, Information or Error (Information is the default setting).
- Change GUI Log Options

Help

- Laser Scanner Instruction Manual—Opens the SX5 Safety Laser Scanner Instruction Manual.
- Zip GUI log
- About—Opens a window that contains the SX5soft release version information.

6.4.2 Toolbar

Button	Name	Function
	Home/Getting Started	Allows the user to start a session by returning to the home page (Task Selection menu page).
	Save	Saves the current configuration or report session.
	Configuration Validator	This tool allows checking the new configuration in SA5soft before sending it to the device. By clicking on this icon, a validation test will be made on the entire configuration in SA5soft. A pop-up window will appear displaying a list of configuration errors or validating the configuration.
	Monitoring	Starts a monitoring session of the connected scanner.
	Help Online	Displays a window that includes the help online guide and it shows the parameters depending on the selected configuration step.

6.4.3 Status Bar







The status bar displays the status of four items (if a scanner is connected and selected).

- Communication status

- Connection type
- Application Scenario
- Scanner status

6.4.4 Task Selection

The right side of the main window includes a list of Tasks that can be selected.

Task Icon	Description
	New Safety System Configuration: to create a Safety System Configuration from scratch.
	Open Safety System Configuration from PC: to open a saved configuration file.
	Modify Safety System Configuration from a Scanner on the Network: to edit a configuration pulled from a scanner on the Network.
	Monitor Safety System: to enter the monitoring function of a connected scanner.
	Read the Safety System Report from a Scanner on the Network: to view, print or save a Safety System Configuration Report from a scanner on the network.
	Read a Safety System Report from PC: to view or print a Safety System configuration report stored on a PC.

6.5 Using the Software

To help the user with the device installation, SX5soft allows users to select the application Type. Depending on which device model is used for the configuration and for the safety monitoring, there are different features and functions.

Basic—The basic model allows the user to choose between the Expert and Vertical scenarios (applications). The basic model employs an 8-pin M12/Euro-style connector, in which three pins are already set for power (Functional Earth, +24 Vdc and Common (0 Vdc)) and 2 pins are used for the OSSD output pair (OSSD 1/1 and OSSD 1/2). As a result, it is possible to assign specific functions to the remaining three pins. These pins can be set as no function or used as follows:

- Input: Restart 1, Reset, Restart 1/Reset, Area Switch, Muting Enable, Muting, Override
- Output: Warning 1, Warning 2, Mute Lamp

Create a New Configuration—Open SX5soft and in the Task Selection panel select **New Safety System Configuration**. After choosing the **New Safety System Configuration**, the subpanel on the left side allows the selection of the device from the **Catalogue** list. Double-click a device to select it.

To proceed with the configuration, click on the white >, in the upper right side on the main panel (under Banner name).

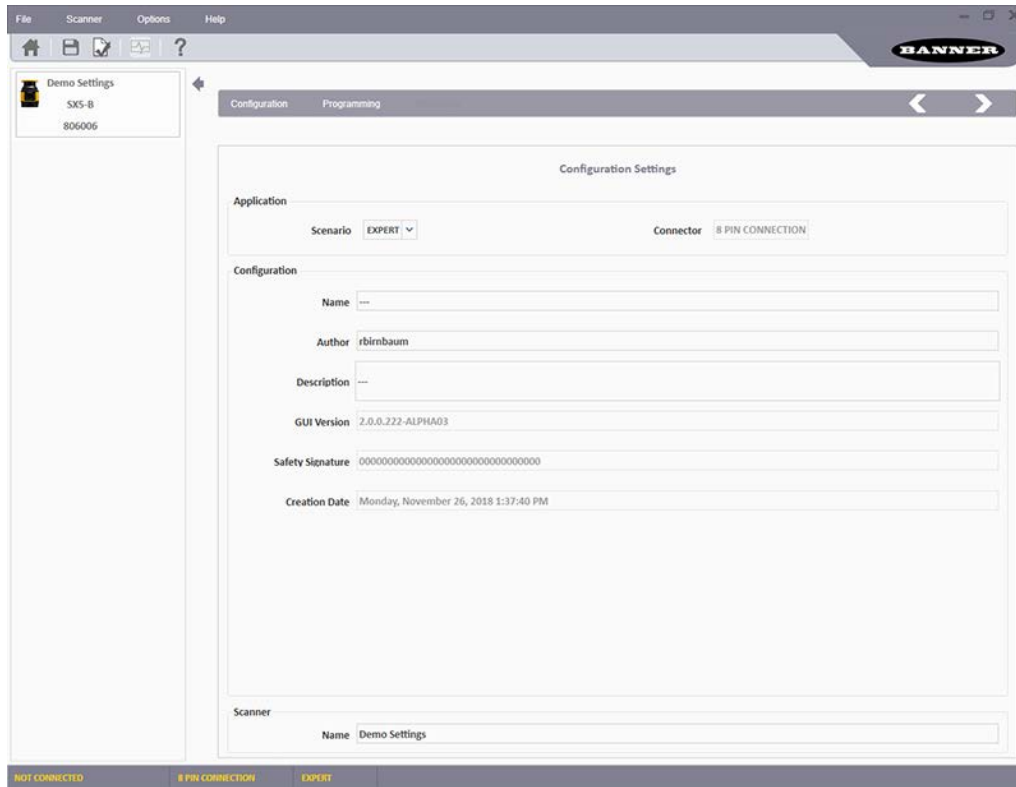

Figure 46. Configuration Settings screen

The **Application** section of the **Configuration Settings** page allows users to define the application by selecting the scenario.

- **Expert Scenario** selection provides the maximum configuration possibilities for the device; contains the entire set of parameters, regardless of the device use.
- **Vertical Scenario** selection provides the extra features/requirements necessary for vertical applications, committing the user to insert the reference point parameter.

Select the 8-pin connection under **Connector**. The configuration manages the pins relative to this connector.

It is possible to edit some of the parameters under the **Configuration** header, such as:

- **Name**—A name to identify the configuration
- **Author**—A name to identify the author (defaults to computer name but can be changed)
- **Description**—A short text description to identify the configuration
- **GUI Version**—(Read-Only) The software version of the GUI.
- **Safety Signature**—(Read-Only) This is automatically generated to be a unique identifier that includes the scanner, configuration, creation date-time.
- **Creation Date**—(Read-Only) The date and time the configuration was created.
- **Scanner**—A name to identify the scanner.

To proceed with the configuration, click on the white > on the upper right side of the main panel. To go back to the previous page, click on the white <.

Save the configuration at any time using the **Save** icon on the tool bar.

6.5.1 Output Configuration

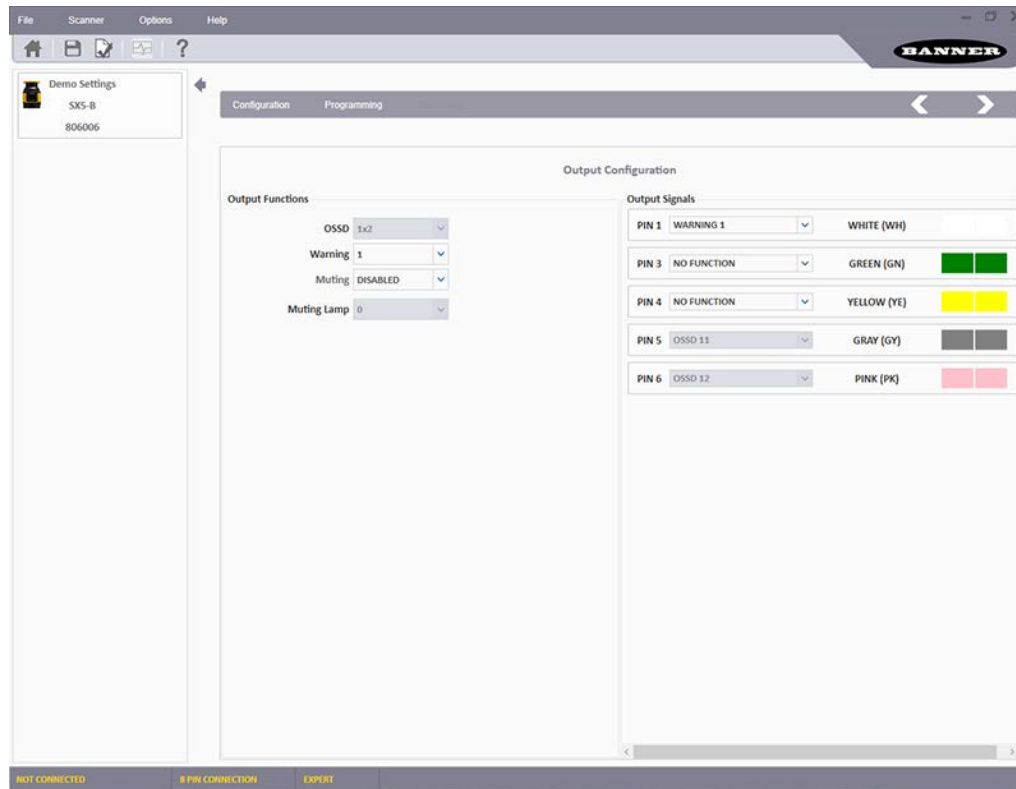

Figure 47. Output Configuration screen

Output Functions

- **OSSD**—to select how many OSSD pairs are used for a given configuration. This component is connected to the machine control system and associated with the Safety Zone. If an object violates the Safety Zone, the OSSD pair switches to the OFF state effectively shutting down the machine. The basic model only has one OSSD output pair.
 - **1x2** (one pair)—All OSSD outputs are managed in pairs, two pins. Pins 5 and 6 are automatically assigned to OSSD 1/1 and 1/2
- **Warning**—to select how many Warning Zones to use for the configuration. This is the area outside the Safety Zone, where an object can be detected but the device will not switch the OSSDs to the OFF-State. It can be used to light a warning lamp or sound a siren. The basic model can have a maximum of two Warning Zones. For each Warning Zone selected an auxiliary warning output is assigned. If no warning outputs are assigned no Warning Zones will be created in the configuration.
- **Muting**—enabling the Muting function allows the scanner to operate under controlled conditions where an object can pass through the Safety Zone without the scanner's OSSD outputs switching to the OFF-State (see [Muting Functions](#) on page 54). Dedicated devices (mute sensors) must be connected to the scanner input signals to control this function. The two possible settings are:
 - **Disable**—No muting abilities
 - **Enable**—Muting turned on, enabling muting limits a configuration to only one Zone Set
- **Muting Lamp**—if the Muting function is enabled, an optional muting lamp can be connected to a scanner output signal to indicate when the scanner is functioning in the Muted condition. The scanner display will always display that the scanner is muted during a muting cycle.
 - **0**—No muting lamp output selected.
 - **1**—Muting lamp output selected

Output Signals—assigning wires to output signals. Pins 5 and 6 are already assigned as the OSSD pair. Pins 1, 3, and 4 can be assigned as inputs or outputs depending on the configuration settings. If the pin is assigned as an output, it cannot be used as an input. From the **Output Function** screen, pins 1, 3, and 4 can be set as follows (depending on configuration settings):

- **No Function**—If the pin is to be used as an input or not at all select no function at this time.
- **Warning x**—Assign the pin as either auxiliary warning output 1 or 2.
- **Muting Lamp 1**—Assign the pin as a mute lamp output if muting is selected.

Click on the white > arrow in the upper right corner to move to the next configuration screen. Click on the white < arrow to return to the previous screen.

6.5.2 Zone Set

A Zone Set is the combination of a configured Safety Zone (SZ) and Warning Zone (WZ). When active, a specific Zone Set has sole control of the safety outputs (OSSD1 and OSSD2) and the Warning auxiliary output, if set in the configuration. This function is useful to change the safeguarding area in applications in which a hazard is not continually present or in applications in which speed and stopping distances varies.

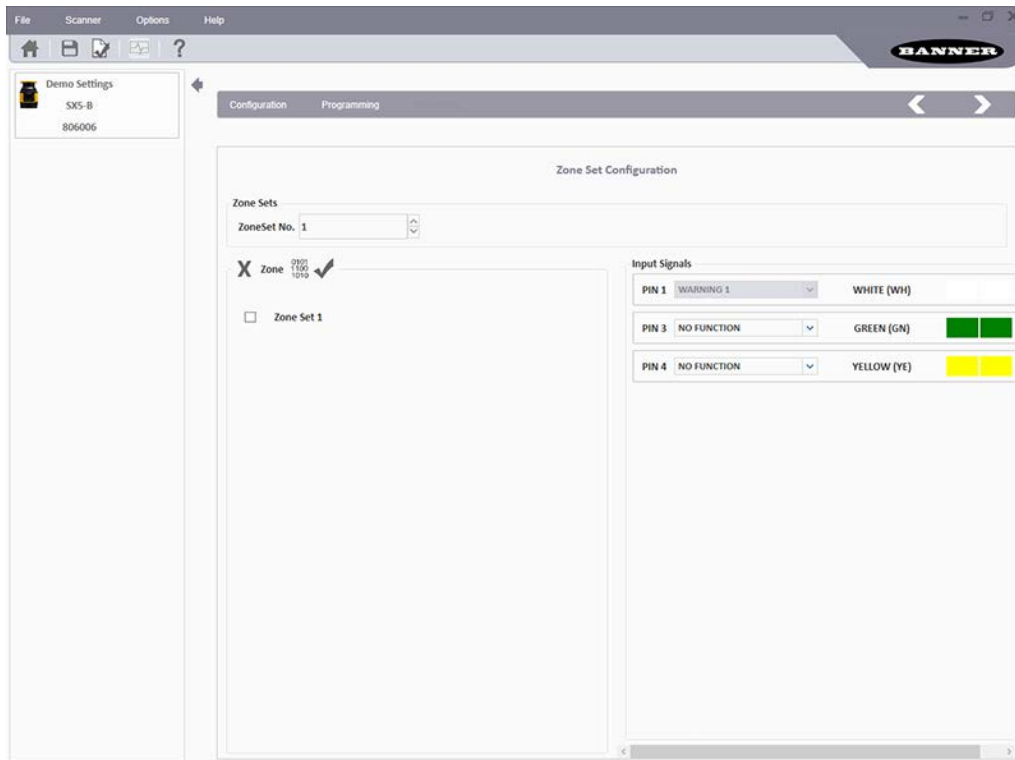

Figure 48. Zone Set screen

More than one Zone Set can be configured to define either separate or overlapping areas and these can be switched between using combinations of input signals.

To create a Zone Set, the user must configure it through the Scanner's GUI.



Note: The basic model has only one OSSD pair, so only one safety area can be defined for each Zone Set.

Single Zone Set Configuration

This configuration step allows the user to set the Zone Set parameters. For this example, the configuration includes only one Zone Set, so it is not necessary to insert or edit any parameters. The Input Wires parameters do not require any assignments in this situation.



Note: When only one Zone Set is selected, up to two Warning Zones can be configured.

Click the white > to move to the next page.

Multiple Zone Sets Configuration

When more than one Zone Set is used, the Zone Set inputs (area switch inputs) are used to select which Zone Set is active. External logic (e.g., a PLC) is capable of selecting one of up to six configured Zone Sets stored in the scanner at any given time.

After the scanner is configured, switching over to or activating an individual Zone Set is controlled by the input pins (area switch inputs) assigned in the configuration software.

The input combination that makes the Zone Sets change (area switch inputs) must be unique and must not be susceptible to false external signals (at least two inputs must change).

**WARNING:**

- **Use Zone Set switching to change the area of safeguarding.**
- Failure to follow these instructions could result in serious injury or death.
- **Changing the Safety/Warning Zone Set from one pair to another must not expose any individual to a hazard or hazardous situation.** Supplemental safeguarding may be required.

The conditions for switching Zone Sets must be in accordance with a risk assessment. Machine stopping/braking distances, scanner system response time (including interfacing devices), machine stop time and other factors that influence the Safety Distance (minimum distance) and Stopping Distance calculations must be considered to safely use the Zone Set switchover function.

In applications that incorporate Zone Set switchover, Minimum Distance D and Side Distance Z must be calculated individually for all Zone Sets. Conditions to allow switching Zone Sets:

- Only one Zone Set can be active after the switchover time; see the Zone Set logic in the configuration software.
- Zone Set switchover is allowed even if there is an intrusion into the active Safety Zone (i.e. OSSDs are off).
- The switchover must be made within the Max Input Delay time selected in the configuration software. The input delay allows waiting for the Area Switching inputs to stabilize from their transient states before accepting the Zone Set change. Otherwise the activation and deactivation (bouncing) of the inputs could put the device into undesired or invalid and temporary switching zone input combinations and therefore cause the device to enter the fault state. The minimum input delay (default) value is 30 ms. It can be increased in 30 ms increments.

In addition, factors dependent on the risk assessment that may affect the safety circuit integrity level include:

- Analyze the means of selecting Zone Sets with respect to failure modes to ensure that an unintended switchover does not occur.
- Ensure that selecting/deselecting Zone Sets does not expose any individual to a hazard. Supplemental safeguarding may be required.

Zone Set Configuration

1. On the **Zone Set Configuration** screen, set the **Zone Set No.**

Depending on the other features used, you can use 1 to 6 different Zone Sets by changing the number shown to match the number of desired Zone Sets.

When increasing the number of Zone Sets, the warning 'To go on, Zones design will be modified' displays. Click **Ok**. The previous settings allow multiple Zone Sets. If a different warning displays, the previous settings must be changed to use multiple Zone Sets.

2. Set the **Input Delay Max** (ms).

After more than one Zone Set is selected, this input field is displayed. This allows the setting of the delay applied between switching from one Zone Set to the next. The input delay allows waiting for the Area Switching inputs to stabilize from the transient states before accepting the Zone Set change. Otherwise the activation and deactivation of the inputs could put the device in an undesired or invalid Zone Set state resulting in a potential unsafe or fault condition. The minimum input delay (default) value is 30 ms. It can be increased in 30 ms increments.



WARNING: Set the **Input Delay Max** time as low as possible because the scanner will not react to violations of the new Zone Set's Safety Zone during this Zone Set changeover time.

3. Set the **Zone** parameters.

This parameter group allows editing the Area Switch input combinations depending on how many Zone Sets are selected. The number of Area Switches (AS#) equal to the number of unassigned inputs will appear in the graphic. Manually set the input switch coding by clicking inside the Area Switch boxes for each Zone Set. To be valid, all Area Switching must differ by two input bit states. It is possible to set the input switch coding with specific function buttons.

- If the configuration includes only one Zone Set, it is not necessary to insert any parameters.
- If two Zone Sets are selected, at least two pins must be assigned to the Area Switch function.
- If 3 to 6 Zone Sets are selected (in this case no other functions are available), pins 1, 3 and 4 must be assigned to the Area Switch function.
- If 4 to 6 Zone Sets are selected, the ability to switch between Zone Sets is limited. This limitation is to ensure that two Area Switch inputs must change to switch between Zone Sets. SX5soft does not obligate changing the Zone Sets sequentially (i.e. Zone Set 1, 2, 3, 4, etc in order), therefore the user must verify that the selected passage from one Zone Set to another (in any order) guarantees that at least two Area Switch inputs change signal levels.

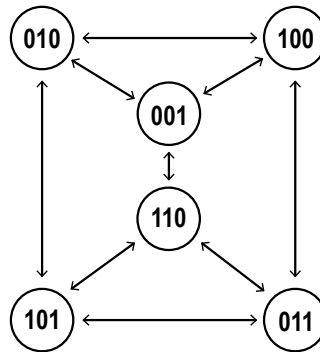

Figure 49. Switching state map

4. Delete, set, or verify the Zone Sets.

- To delete the selected Zone Set, click the X icon.
- To automatically set the Zone Set combinations, click the binary icon.
- To verify the Zone Set combinations, click the checkmark icon.

5. Set the **Input Signals** (wires).

This parameter group assigns the signals of the input functions to the scanner pins. Each pin is also associated with color-coded cable wiring, according to safety equipment regulations and standards. Pins already assigned as an output are grayed out. Pins 1, 3, and 4 can be assigned as Area Switch Inputs (1, 2, or 3 depending on the number of Zone Sets used).

Click on the white > arrow in the upper right corner to move to the next configuration screen. Click on the white < to return to the previous screen.

6.5.3 Input Configuration

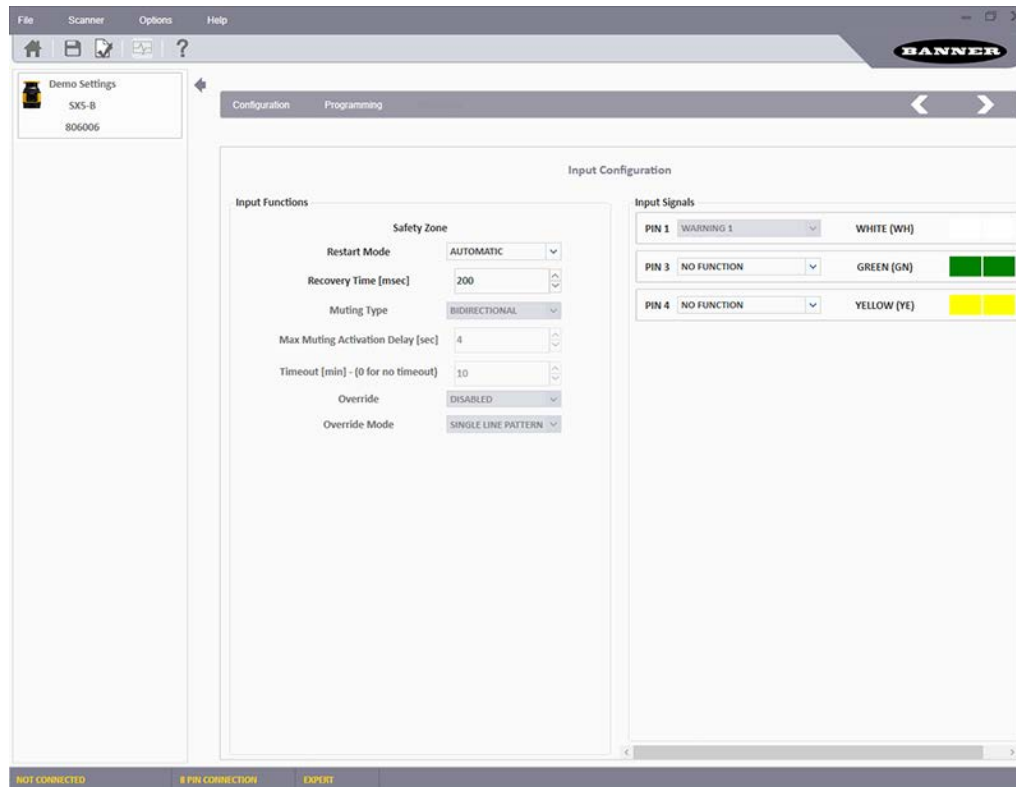

Figure 50. Input Configuration screen

- Under **Safety Zone** in the **Input Functions** section, configure the **Restart Mode**.

- **Automatic**—The scanner automatically returns the OSSD pair to the On-State after all detected objects are removed from the Safety Zone and the configured Recovery Time elapses.
- **Manual**—The scanner returns the OSSD pair to the On-State after all detected objects are removed from the Safety Zone and a manual Restart switch (reset push-button) is pressed for at least 500 ms, but no longer than 4.5 seconds.

- Define the **Recover Time**.

This parameter is only configured for Automatic Restart Mode. The Recover Time is the time between the object removal from the Safety Zone and the OSSDs going to the On-State. Select the time to elapse before the OSSD pair returns to the On-State. The minimum time is 200 ms. This can be increased to 60,000 ms in 1 ms increments. Default: 200 ms

- Define the **Muting Type**.

If muting is not selected, this option is grayed out. The Muting function can be used in two different configurations.

- **Bidirectional**—Used when objects can pass through the Safety Zone from either direction; requires two or four muting sensors be connected to the scanner inputs
- **Unidirectional**—Used when objects can pass through the Safety Zone from only one direction (out of the hazardous area); requires two muting sensors be connected to the scanner inputs
- **M coeff.**—If Unidirectional Muting is selected, the M coeff is displayed. The M coefficient is the time delay multiplier that times out the Muting function after a mute sensor clears (typically mute 1). The M coeff can be set from 2 to 16. This is the multiplier of the activation delay between the initiation of the two muting sensors. The maximum amount of time that the system will stay muted after the clearing of mute 1 is M Coeff × Max Inputs Delay (actual elapsed time between the activation of mute 1 and mute 2).

- Define the **Max Inputs Delay** (seconds).

The maximum allowable time delay between activation of mute 1 and mute 2. This parameter can be set from 1 to 16 seconds with the default being 4 seconds. If muting is disabled, this field cannot be adjusted.



CAUTION: The maximum input delay is based on the conveyor speed and package length. Set the delay long enough to ensure only the package is passing through the curtain and short enough to prevent inappropriate or unintended muting cycles.

5. Define the **Timeout** (minutes).

This parameter allows the entering of a muting backdoor timer (maximum time to stay muted). The default time limit is 10 minutes. The time limit can be increased from 10 minutes to 1080 minutes in 1 minute increments. For no time limit, enter 0.



WARNING: Select an infinite time for the Muting Time Limit only if the possibility of an inappropriate or unintended mute cycle is minimized as determined and allowed by the machine's risk assessment. The user is responsible to make sure that this does not create a hazardous situation.

6. Enable or disable **Override**.

If muting is enabled, an override function can also be enabled. The override allows OSSDs to be manually forced on to drive an item out of the Safety Zone.



WARNING: Measures must be taken to prevent activation of the mute-dependent override function from a fault or inadvertent operation of the initiating device.

7. Set the **Override Mode**, if applicable.

The only override mode available in the basic model is the single-line pattern. This is a single input to force the scanner's OSSD output on. The hazardous motion should not start until the initiation button of the machine is also engaged. The override time limit is 120 seconds.

8. In the **Input Signals** section, assign pins 1, 3, and 4 as a Reset, Restart 1, Restart 1 Reset, Muting Enable, Muting 1 1, Muting 1 2, or an Override 1 1 input depending on the configuration.

- **Reset**—The reset input function can be added in Automatic or manual reset mode. The reset input allows restoring normal operation after a failure lockout (fault) condition, due to system error, without disconnecting the power.
- **Restart 1**—The restart input function is only added in manual reset mode. The restart input turns on the OSSD outputs after the blockage has been removed from the Safety Zone (and at startup).
- **Restart 1 Reset**—This selection will perform whichever input is needed at the moment (reset for faults, restart for manual reset situations).

This parameter group assigns the signals of the input functions to the scanner pins. Each pin is also associated with color-coded cable wiring, according to safety equipment regulations and standards. Previously assigned pins are grayed out.

Click on the white > arrow in the upper right corner to move to the next configuration screen. Click on the white < to return to the previous screen.

6.5.4 Detection Configuration

Use the **Detection Configuration** screen to define the Safety Zone and Warning Zone parameters.

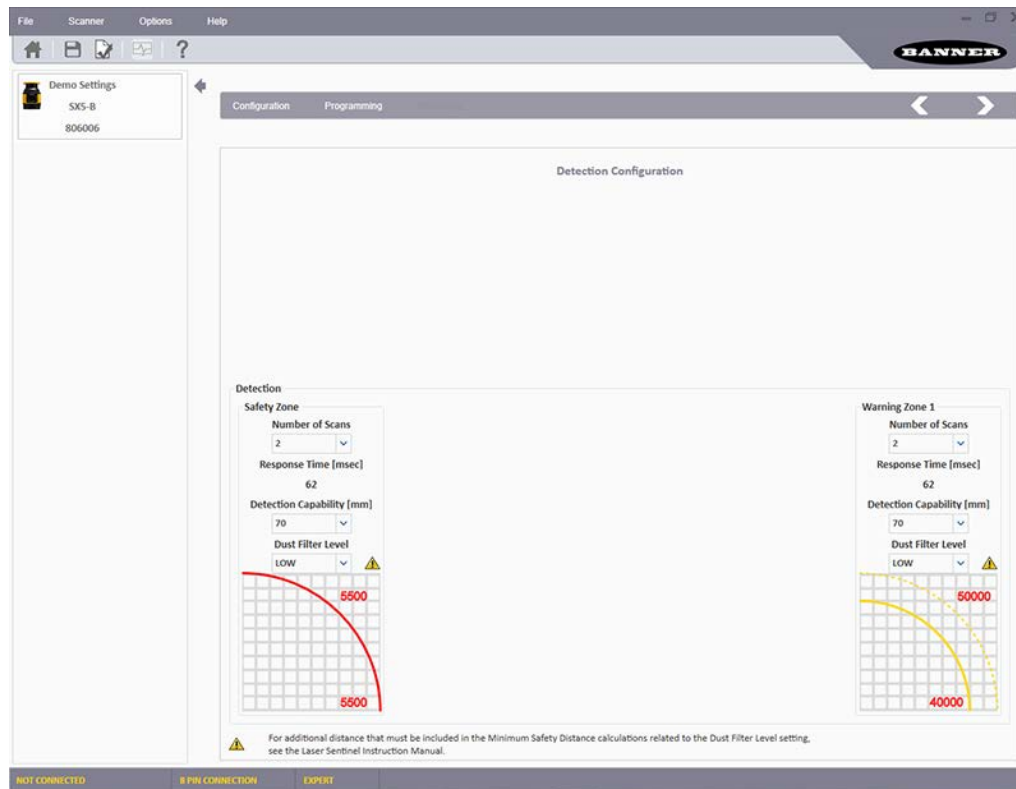

Figure 51. Detection Configuration screen

1. Set the **Number of Scans** required to validate detection of a Safety Zone intrusion.
This parameter directly affects the Response Time, which is the time from when an object is detected in the Safety Zone to when the OSSD switches to the OFF-State.
The **Response Time** (ms) is automatically generated based on the **Number of Scans** selected. Response time ranges from 62 ms to 482 ms, in 30 ms increments.
2. Set the **Detection Capability** (mm).
This parameter sets the scanner's detection resolution ability. The resolution does affect the maximum range of the scanner. The two options are 70 mm or 40 mm resolution.
3. Set the **Dust Filter Level**.
This parameter must be set according to different conditions specific to the application. In general, it is the sensitivity to various levels of airborne particles that affect the response of the scanner's detection abilities. Increasing the Dust Filter Level can increase the Minimum Safety Distance if certain lighting conditions exist. See [Dust Filtering](#) on page 28.



CAUTION: Set the Dust Filter Level to the lowest value that still allows the machinery to work without detections from dust.

- High—Use in dirty environments to filter (ignore) detection of airborne particles from being confused with objects to detect. The scanner is less sensitive to dust and therefore avoids shutting down the machinery unnecessarily.
 - Med—Use in environments where some airborne particles are present and can influence object detection.
 - Low—Use in cleaner environments where airborne particles have little effect on object detection.
4. Set these same parameters for the Warning Zone if a Warning Zone output is used.



Important:

In addition to the level of airborne particles in the scanner's environment, some special lighting conditions also affect the detection sensitivity. These conditions are:

- high reflective backgrounds within 3 meters of the Safety Zone boundary
- the presence of bright light within +/- 5 ° of the detection plane.

Include an additional distance in the Minimum Safety Distance calculations for these cases. See the graphs in the SX5's instruction Manual for these additional distances.

Click on the white > arrow in the upper right corner to move to the next configuration screen. Click on the white < to return to the previous screen.

6.5.5 Create or Edit Safety and Warning Zones

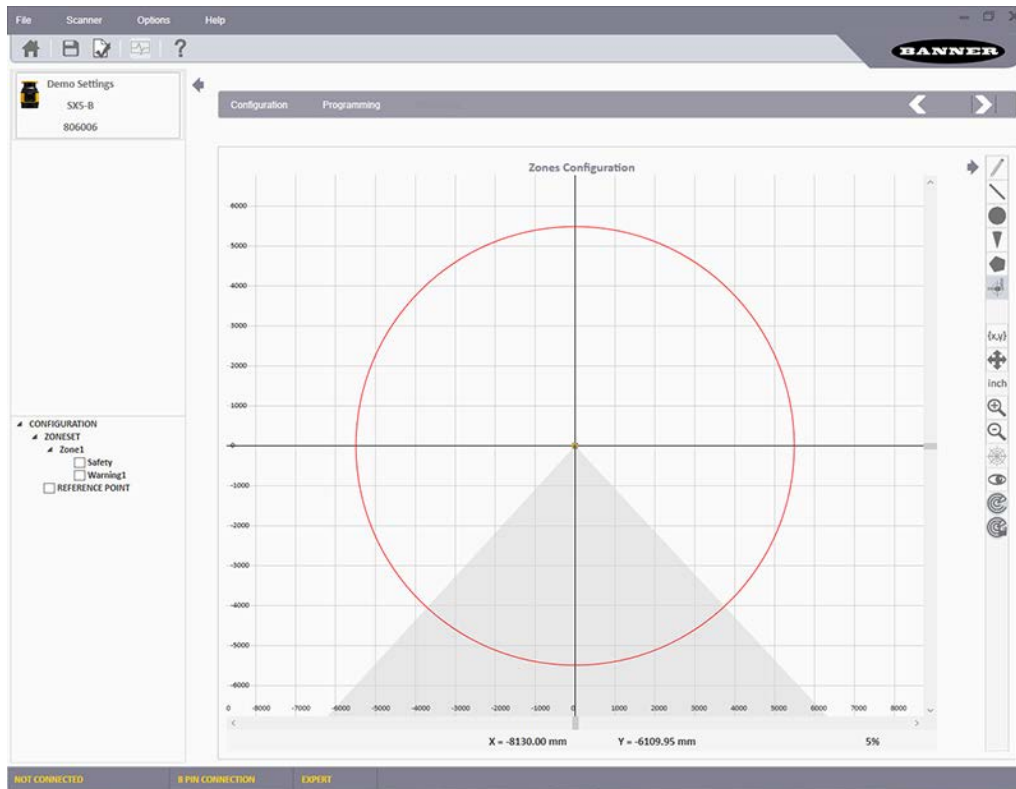

Figure 52. Zone Configuration screen

Tools are provided to draw the Safety and Warning Zones. It is possible to select different shapes and different functions to manage the graphing.

- On the right are the various configuration icons.
 - On the left are a list of the various zones that can be configured.
 - In the center is the area graph. The center of the scanner is the point where the two axes intersect.
1. In the left panel, click on the zone name to edit. Do not select the zone checkbox. The zone must be highlighted to be edited or displayed. If no zone is highlighted, Zone 1 - Safety is being created. To modify an existing zone, right-click on the zone name.

2. Select the zone shape from the options on the right side of the screen.

When modifying an existing zone, you may copy zone shapes between zones (Safety and Warning), move a zone shape between zones (Safety and Warning), edit a zone shape, or delete a zone shape.

- **Free-Hand Zones**—Click on the pencil icon to free-hand draw the desired zone shape. Click and hold on the graph starting point (lowest point on either side of the scanner). Move around the scanner to map the outer edge of the zone. When the zone is complete release the mouse button.
 - **Line Zones**—Click the line icon to draw a triangular shaped zone whose far edge is defined by the line. Then click and hold on the graph at the starting point of the line (lowest point on the right side of the shape or lowest point on the left side of the desired shape). Move up and left (or up and right) to draw the straight line. Release the left mouse button to finish the line.
 - **Circular Shaped Zones**—Click the circle icon to draw a circular shaped zone. Click and hold the cursor on the graph. Moving the cursor in and out changes the size of the circle up to the maximum range of the unit. When the desired diameter is reached, release the mouse button.
 - **Arc Zones**—Click on the cone icon to draw a triangular shaped zone whose far edge is defined by an arc (rounded not straight). Click and hold on the graph at the lowest left hand starting point of the zone. Move to the right side ending point of the zone and release the button.
 - **Polygon Shaped Zones**—Click on the polygon icon to draw a polygonal shaped zone. Click at the starting point of the desired polygonal zone. Move to the next edge transition point and click again. Keep clicking at the transition points. To finish the zone, double-click at the final point of the shape.
 - **Numerically Generated Zones**—Click on the coordinate icon to numerically enter coordinates to create graphical zones. Coordinates for circles, lines, arcs, and polygons can be entered.
3. To edit a zone, right-click on the zone in the graph, select **Shapes** from the menu that opens, select the desired shape to edit, then select edit. To exit editing mode, repeat this step.

Click the eye icon to show Zone transition points and allow the editing (moving) of those points. After the changes are complete, click the eye icon again to leave editing mode.

6.5.6 Use TEACH In to Assign Safety and Warning Zones



Note: TEACH IN and draw TEACH in Zone are available only if a scanner is online.

You may use the TEACH In function to outline the space the scanner is guarding, then go back and use shapes. Or you can use the TEACH In Area Assignment to set the fields in the detected area, up to the maximum range.

1. Click the TEACH icon to enter **TEACH In** mode.
TEACH In scans and displays the area surrounding the scanner. The white area is free of obstacles and can be assigned to a Safety or Warning Zone. The gray areas contain detected obstructions.
2. Select the Safety Zone or Warning Zone in the left pane.
3. Click the TEACH In Area Assignment icon to assign the defined area to the selected zone.

6.5.7 Protecting a Vertical Area (Reference Points)

When the scanner is mounted to protect a vertical area (up and down), add Reference Points to an edge.

These reference points are positions where something will always be sensed by the scanner (the surface will always be present). These points are used by the scanner to ensure that it has not come loose from its mounting surface and is protecting the correct area. A minimum of three reference points must be added. A maximum of 15 reference points can be added.

1. To add a reference point, highlight Reference Point at the bottom of the list of Zones on the left.
The reference point icon becomes live.
2. Click on the Reference Point icon on the right.
3. Click the locations of the desired Reference Points.
The maximum distance from the scanner is 5500 mm for 70 mm resolution or 3000 mm for 40 mm resolution. The Reference Points do not have to be at the edge of the Safety Zone.

6.5.8 Connect a Scanner to a PC (Discover the Scanner)

Enter Discovery mode to have the software search the PC's network for any connected SX5s.

Attach new scanners one at a time to the LAN because they all have the same default IP Address (192.168.0.10). After new IP addresses have been assigned, multiple units can be attached to the same network.

1. Enter **Discovery** mode using one of these three methods.
 - Click on **Programming**. After the configuration file is uploaded to the scanner, the software enters Discovery mode.
 - Go to the **Scanner > Discovery** menu.
 - From the **Task Selection** area, select **Modify Safety System Configuration** for a scanner on the network.

If a pop-up windows appears asking to allow SX5soft access through the Windows Firewall, click **Accept**. If the window does not appear, verify that the firewall is set to allow SX5soft access. If access is not allowed, the scanner is discovered, but no information can be sent to or received from the scanner.



Note: If at anytime a notice pops up saying 'the scanner is busy' verify that the software has access through the Windows Firewall.

2. SX5soft displays the device with its own IP Address.
3. Double-click on the scanner to place it in the **Device Configuration Panel**.
4. Click on the white > in the upper right side on the main panel to proceed.
A pop-up window suggests aligning the IP Address of the device with the computer LAN.
5. Click **OK** and enter the password (the default password is 'admin').
6. Change the IP Address parameters in the **Network Configuration** screen to align them with the computer LAN.



Important: The displayed IP address is assigned to the SX5. The successive address is also reserved because both internal micros have their own IP address. For example, if the displayed Scanner IP address is 192.168.0.10, the successive address of 192.168.0.11 is also assigned and cannot be used as the computer LAN IP address.

7. Click **OK** to accept the new IP Address parameters. When the device enters Offline status, click **OK** to continue. SX5soft automatically rediscovers the scanner with the new IP Address.
8. Double-click on the SX5 to enter **Programming**.

Aligning IP Addresses

Assuming the Subnet Mask is at the typical default setting of 255.255.255.0, the first three octets of the IP address must match (192.168.0 of the 192.168.0.10).

Change the scanner's IP address to match the LAN of the PC or change the PC's IP address to match the LAN of the scanner.

6.5.9 Validate and Accept the Configuration

Use the Programming screen to upload a configuration file to the scanner, generate a Safety Report, and validate the loaded configuration after the configuration is tested with the **Monitoring** function.

1. Click on **Programming** in the right window header, or use the white arrows on the right side to advance (or return) to the **Programming** screen.
2. In the **Configuration Upload** section, click **Load** to send the configuration to the scanner.
3. Enter the password (default is `admin`) when asked.
While the configuration is loading the scanner enters an OFF state.
4. To validate the configuration:
 - a) Enter **Monitoring** mode. After the new configuration is received by the scanner it will display the green Go icon.
 - b) On the **Programming** screen, the Report file displays on the right. This report sums up the configuration steps with all the selected parameters. The Safety Report displays the new and previously used parameters (if editing an existing configuration, the previous parameters are in red).
5. Optional: Print the Safety Report or save the Safety Report to a PDF.
6. Accept or reject the configuration. If the configuration passes the testing and has been validated, accept it.



WARNING: By validating (accepting) the configuration the responsible party takes on responsibility for the created configuration, accepting the hazard due to configuration errors.

6.5.10 Monitor the Scanner





When in the **Monitoring** mode, the graph displays the current working area of the scanner. Use this function to verify that the designed Safety and Warning Zones are designed correctly (provide the desired protection). This function is also used to watch the functioning of the scanner during operation. The **Monitoring** function is only available when an online scanner has been selected.



Tip: If you click on **Monitoring** and receive a message that the scanner is busy, verify that the software has access through the Window's firewall.

On the left panel, the software displays the scanner status (if it is currently functioning). It is also possible to view some parameters like response time by clicking on the Parameters icon, view pin assignments by clicking on the Connector icon, or view fault information by clicking on the Diagnostic icon.

The following icons, located on the right side of the graph, allow the users to manipulate the display.

Icon	Function
	Saves the Monitoring information into a .txt file
	Moves the graph origin on the page. After clicking on the button, click and hold on the graph to move it around (up, down, right or left). After you position the graphic, release the mouse button. Click on the icon again to set the location.
	Toggles the graph polar (r, θ) and Cartesian (x, y) coordinates.
inch	Toggles the graph unit of measure between mm and inches.
	Zooms in on the graph.
	Zooms out on the graph.

6.5.11 Save a Configuration File

After a configuration is complete or even partially created, you may save your file to your hard drive.

1. Go to **File > Save**.
2. Browse to the location on your hard drive to save the file to.
3. Name your configuration file.
4. Click **Save**.

6.5.12 Edit an Existing Configuration

To edit an existing configuration, follow these steps.

1. To edit an existing configuration on your hard drive, follow these steps:
 - a) In the software, select the file folder icon or go to **File > Open Safety System Configuration from PC**.
 - b) Browse to the file location on your hard drive and select it.
 - c) Click **Open**.

2. To edit an existing configuration on a Scanner on the network, follow these steps:
 - a) In the software, click on **Modify a Safety System Configuration from a Scanner on the Network**. The software enters **Discovery** mode to search for all connected scanners. The software opens and displays the device with its IP Address (default is 192.168.0.10).
 - b) Double-click the discovered device to place it in the **Device Configuration** panel.
 - c) Click on the white > arrow to advance to the next screen.
 - d) If the IP Address has not been changed, a pop-up window suggests changing the IP Address of the scanner to that of the computer LAN. Click OK to proceed and insert the scanner password (default password is `admin`).
 - e) Change the IP Address parameters in the **Network Configuration** window to match them to the computer LAN. The scanner reserves the successive IP address for internal functions (both internal micros have their own IP Address but you access them using the assigned address).
 - f) Click **OK** to accept the new IP address. The device enters the Offline status.
 - g) Click **OK** to continue.
 - h) The software automatically rediscovers the scanner at its new IP Address. Double-click on the scanner to modify the configuration.
3. Click on the white > arrow to move to the configuration screens, edit the configuration, or to upload the configuration to a scanner.

6.5.13 Wink Function

Use the Wink function to recognize which device is to be configured when multiple devices are found on the network.

To activate the Wink function, click on the Wink button when the device is in Discovery mode. The Wink icon displays.

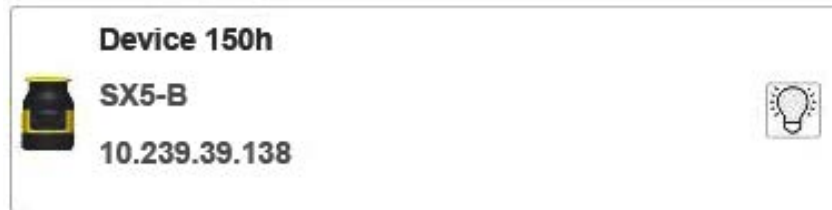

Figure 53. Wink button



Figure 54. Wink icon blinks on/off on the unit's display



Figure 55. Wink button blinks

6.6 Print the Safety System Report

A scanner configuration's Safety System Report contains the following information:

- Configuration Administrative Parameters
- Scanner Identification
- Wiring information
- Outputs selected
- Zone(s) selected
- Input(s) selected
- Detection Parameters
- Zone Sets (graphic display of fields)

After the configuration has been uploaded to the scanner, the report is generated. To print out your report, follow these steps.

1. Access the Safety System Report.
 - Go to the **Programming** screen after loading a configuration into a scanner
 - From the software's home screen, select **Read a Safety System Report from a Scanner on the Network**
 - From the software's home screen, select **Read a Safety System Report from PC**
2. Select the appropriate icon to either print the report to a printer or to a PDF file.

6.7 Change the Password

To assign or change a scanner's password, the device must be connected (online).

1. Verify the scanner is selected in the software (displays in the right panel).
2. Go to the **Scanner > Select Settings > Change Access Control** menu.
3. When asked, enter the current password.
4. Enter the new password (twice) then choose the password type.
 - Write Only—Required only when loading the configuration to a scanner
 - Read/Write—Required when connecting and when loading a configuration
 - None—Allows the user to enter monitoring but not to make any changes

Click **OK**.

6.8 Reset the Password

To reset a forgotten or lost password, the device must be connected (online).

1. Verify the scanner is selected in the software (displays in the right panel).
2. Go to the **Scanner > Settings > Reset Password** menu.
3. Contact Banner Engineering Technical Support and send the serial and the magic number shown.

The "magic number" is based on the run-time of the scanner, so this number is time sensitive. To contact the Safety Application Engineering, call Banner's North American headquarters at 763-544-3164 or 1-888-373-6767 (toll free).

A new password will be given to you.

6.9 Configure a Static IP Address

To connect a device to the software using the Ethernet TCP/IP interface, match the Ethernet IP Addressing parameters between the configuration PC and the scanner.

The default scanner static assignment Ethernet IP Address is: 192.168.0.10. The successive IP Address is reserved for internal scanner functions (for example, 192.168.0.10 and 192.168.0.11 are used by the scanner).

1. Before changing the Ethernet network settings on the PC running the software, close any open applications that use network resources (email, web browsers, etc).
2. On the PC, go to the **Control Panel** and select **Network and Sharing Center**.
3. Click on the **Local Area Connection** link and open the properties window.
4. Select **Internet Protocol Version 4 (TCP/IPv4)** and open the properties window.
5. Set the **IP address** fields.









For example, set the **IP address** to: 192.168.0.38 (the 38 can be any address other than ones used by a scanner).
Leave the **Subnet mask** to 255.255.255.0.
6. Click **OK** to save.

7 Operating Instructions

7.1 Status Indicators

The SX5 has three buttons, a graphical display, and five status LEDs (located below the display).

The SX5 has diagnostic LEDs for initial diagnostics. The OFF state and ON state LEDs are below the scanner's display. When it is not possible to see the display because of the way it was mounted or because it is hidden from the operator's position, use the software's **Monitoring** function to check the status.

	Symbol	Meaning
 <p>Figure 56. Status LEDs</p>		LED 1: Object Detection in Safety Zone (OSSD 11/12) Red—Object detected in the Safety Zone Green—No object is detected in the Safety Zone
		LED 2: not available
		LED3: Assigned to Warning Zone 2 Amber—Object detected in Warning Zone 2 OFF—No object detected in Warning Zone 2
		LED 4: Assigned to Warning Zone 1 Amber—Object detected in Warning Zone 1 Off—No object detected in Warning Zone 1
		LED 5: Interlock Amber—Interlock function active (waiting for a restart signal)
		Button 1: to browse quickly the Menu functions (up)
		Button 2: to enter and confirm the selected function
		Button 3: to browse quickly the Menu functions (down)

7.2 Display Menu

To enter the Display menu, push the square button. The display supplies information about the status of the scanner and for diagnostics and troubleshooting. The menu is divided into three main areas (Information, Settings, and Exit). Use the up and down arrow buttons to browse the menu structure.

- **Information**—Accesses the hardware and configuration options
- **Settings**—Accesses Display Settings and Reset options
- **Exit**—Select Exit and push the square button to exit the menu option

7.3 Resetting the System

Perform system resets and scanner restarts using an external reset switch.

If supervisory control of the reset/restart switch is required, a key switch may be used, with the key kept in the possession of a Designated or Qualified Person. Using a key switch will also provide some level of personal control, since the key may be removed from the switch. This will hinder a reset/restart while the key is under the control of an individual, but must not

be relied upon solely to guard against accidental or unauthorized reset. (Spare keys in the possession of others or additional personnel entering the safeguarded area unnoticed may create a hazardous situation.)

Pins 1, 3, or 4 can be configured as a reset/restart input if needed in a configuration.

The SX5 requires a manual restart to clear a Start/Restart Interlock condition and resume operation following a stop command. Internal Lockout conditions also require a manual reset to return to Run mode after the failure has been corrected.

To reset/restart the SX5, close the reset/restart switch for 0.5 to 4.5 seconds and then open it. Closing the reset/restart switch too long causes the sensor to ignore the reset/restart request.

7.3.1 Reset Signal Function

There are two internally controlled states between the stop and restart of the scanner:

- Interlock ON: Device can be restarted to its normal function because the detected object has been removed from the Safety Zone
- Interlock OFF: Device is off because the object has not been removed from the Safety Zone

The Interlock ON will be signaled by the LED 5 (right LED under the device display) turning amber and the display showing Restart inside a circle.

The manual reset input must be connected to +24 V dc via a Normally Open switch contact.

8 Checkout Procedures

8.1 Periodic Checkout Requirements

This section lists the schedule of checkout procedures and describes where each procedure is documented. Checkouts must be performed as described. Results should be recorded and kept in the appropriate place (for example, near the machine, and/or in a technical file).

Banner Engineering highly recommends performing the System checkouts as described. However, a qualified person (or team) should evaluate these generic recommendations considering their specific application and determine the appropriate frequency of checkouts. This will generally be determined by a risk assessment, such as the one contained in ANSI B11.0. The result of the risk assessment will drive the frequency and content of the periodic checkout procedures and must be followed.

At every shift change, power-up, and machine setup change, perform the Daily checkout. This checkout may be performed by a Designated or Qualified Person (see the Daily Checkout Card for the procedure).

Semi-annually, the Scanner and its interface to the guarded machine should be thoroughly checked out. This checkout must be performed by a Qualified Person (see the Semi-Annual Checkout Card for the procedure). A copy of these test results should be posted on or near the machine.

When changes are made to the System (either a new configuration of the Scanner or changes to the machine), perform the Commissioning Checkout.



WARNING:

- Verify the proper operation of this SX5 Safety Laser Scanner
- Failure to verify the proper operation, on a regular basis, can result in undetected problems, which if not corrected, can result in serious injury or death.
- It is the user's responsibility to verify proper operation on a regular basis.

Study each procedure in its entirety, to understand each step thoroughly before beginning. Refer all questions to a Banner applications engineer (see *Contact Us* on page 91). Checkouts must be performed as detailed and results must be recorded and kept in the appropriate place (e.g., near the machine, and/or in a technical file). This must include a printout of the SX5's configuration and the shape of all Safety Zones.

Additional factors and checks may be required that are dependent on the application, machine, or local regulations and laws. A user risk assessment will determine what these additional factors and checks will be and should be incorporated with the checkouts below. For easy reference, print out the procedures and post them near the machine/application.

8.2 Schedule of Checkouts

Checkout cards and this manual can be downloaded at <http://www.bannerengineering.com>.

Checkout Procedure	When to Perform	Where to Find the Procedure	Who Must Perform the Procedure
Trip Test	At Installation Any time the SX5, the guarded machine, or any part of the application is altered.	<i>Perform a Trip Test</i> on page 50	Qualified Person
Commissioning Checkout	At Installation When changes are made to the SX5 (for example, either a new configuration of the SX5 or changes to the guarded machine).	<i>Perform a Commissioning Checkout</i> on page 79	Qualified Person
Shift/Daily Checkout	At each shift change Machine setup change After the SX5 is powered up During continuous machine run periods, this checkout should be performed at intervals not to exceed 24 hours.	Daily Checkout Card (Banner p/n <i>208912</i>) A copy of the checkout results should be recorded and kept in the appropriate place (for example, near or on the machine, in the machine's technical file).	Designated Person or Qualified Person
Semi-Annual Checkout	Every six months following SX5 installation, or after changes are made to the SX5 (either a new configuration of the SX5 or changes to the machine).	Semi-Annual Checkout Card (Banner p/n <i>208911</i>) A copy of the checkout results should be recorded and kept in the appropriate place (for example, near or on the machine, in the machine's technical file).	Qualified Person

8.3 Perform a Commissioning Checkout

Perform the Commissioning Checkout procedure as part of the SX5 installation (after it has been interfaced to the guarded machine as described) or after changes are made to the system (either a new configuration of the SX5 or changes to the machine).

Perform the Commissioning Checkout procedure after:

- Configuring the SX5 with the configuration software
- Connecting to the 8-pin M12/Euro-style pigtail of the SX5 to the control system or safety switching device
- Verify the cover to the 4-pin M12/Euro-Style Ethernet connector is in place over the connector or a cable is securely connected.

Record the checkout results and store on or near the guarded machine as required by applicable standards.



WARNING:

- There is a risk of unpredictable machine behavior at the initial start up of the machine.
- Failure to follow these instructions could result in serious injury or death.
- The Qualified Person must take precautions to ensure that no one is in or near the hazardous area during these safety system tests.

1. Examine the guarded machine to verify that it is of a type and design compatible with the SX5. For a list of appropriate and inappropriate applications, see [Appropriate Applications](#) on page 9.
2. Verify the SX5 is configured for the intended application and all mounting hardware is secured.
3. Verify that the minimum safety (separation) distance from the closest hazard of the guarded machine to the Safety Zone(s) is not less than the calculated distance. See [Minimum Safety \(Separation\) Distance for Stationary Applications](#) on page 29 and [Mobile Applications](#) on page 33.
4. Verify that:
 - a) Access to any dangerous parts of the guarded machine is not possible from any direction not protected by the SX5, hard guarding, or supplemental safeguarding; and
 - b) It is not possible for a person to stand between or climb over/under the protected Field(s) and the dangerous parts of the machine, or stand on top of the SX5; or
 - c) Supplemental safeguarding and hard guarding, as described by the appropriate safety standards, are in place and functioning properly in any space between the Safety Zone(s) and any hazard that is large enough to allow a person to be undetected by the SX5.
5. Verify that all reset switches are mounted outside and in full view of the guarded area, out of reach of anyone inside the guarded area, and that means of preventing inadvertent use is in place.
6. Examine the electrical wiring connections between the Scanner OSSD outputs and the guarded machine's control elements to verify that the wiring meets the requirements stated in [Electrical Connections](#) on page 41 and [Electrical Connections to the Guarded Machine](#) on page 42.
7. Remove all obstructions from the Safety Zone(s). Apply power to the SX5 system. Verify that power to the guarded machine is off.
 - **If the SX5 is configured for Start Interlock (Manual Power-Up)**, LED 1 will show green, LED 5 will be on and the display shows RESTART (Interlock 1). Perform a manual reset (close the reset switch for 0.5 to 4.5 seconds, then open the switch) to turn on the OSSD outputs.
 - **If the SX5 is configured for Automatic Start (Automatic Reset)**, LED 1 will show GREEN and the display will show GO, and the OSSD outputs turn on (after the restart delay time).
8. Observe the Diagnostic Display.
 - **Lockout**—Lockout information listed on the display.
 - **Safety Zone interrupted**—Red STOP shown on display with direction of interruption also red.
 - **Safety Zone Clear and OSSDs on**—Green GO shown on the display.
 - **Start/Restart Interlock (OSSDs off, waiting for reset)**—Restart in a circle with Interlock below it shown on the display.
9. An interrupted Safety Zone (SZ) condition indicates that one or more objects are being detected within the active protected Zone. To correct this situation, identify the interruption using the software's **Monitoring** mode or by observing the area covered by the Safety Zone, and then remove all objects or realign the SX5. If the system is in a Start/Restart Interlock (waiting for Reset) condition, perform a manual reset.

10. After the display shows the green GO, perform the trip test ([Perform a Trip Test](#) on page 50) on each of the configured Safety Zones to verify proper system operation and to detect possible unmonitored areas. Verify that if the Safety Zone boundary is identified (for example, marked on the floor), that it matches the corresponding Safety Zone. Do not continue until the SX5 System passes the trip test. Do not expose any individual to any hazard during the following checks.



WARNING:

- Before applying power to the machine, verify the area is clear.
- Failure to follow these instructions could result in serious injury or death.
- Verify the guarded area is clear of personnel and unwanted materials (such as tools) before applying power to the guarded machine.



WARNING:

- If the trip test fails, do not use the system.
- Failure to follow these instructions could result in serious injury or death.
- If the SX5 does not respond properly to the trip test, do not attempt to use the system. If this occurs, the SX5 cannot be relied on to stop dangerous machine motion when a person or object enters the Safety Zone.

11. Apply power to the guarded machine and verify that the machine does not start up. Interrupt the Safety Zone with the appropriate test piece (whose size matches the configured resolution) and verify that it is not possible for the guarded machine to be put into motion while the Safety Zone is interrupted. Repeat for each configured Safety Zone.
12. Initiate the machine cycle or motion of the guarded machine or mobile vehicle. While it is moving, use the appropriate test piece to interrupt the Safety Zone. Do not attempt to insert the test piece into the dangerous parts of the machine or directly in the path of the moving vehicle. Upon interrupting the Safety Zone (at any point), verify that:
- a) **For stationary applications:** The dangerous parts of the machine come to a stop with no apparent delay. Remove the test piece from the Safety Zone; verify that the machine does not automatically restart, and that the initiation device(s) must be engaged to restart the machine.
 - b) **For mobile applications:** The vehicle stops within the identified/predetermined distance. Remove the test piece from the Safety Zone; verify that the vehicle does not unintentionally restart, and, if required, that the initiation device(s) must be engaged to restart the mobile vehicle. This must be accomplished at numerous points along the entire route (for example, testing each of the Field Pairs in the configuration).
13. Remove electrical power to the SX5. Verify that both OSSD outputs immediately turn off and the machine is not capable of starting until power is re-applied to the SX5.
14. Test the machine stopping response time, using an instrument designed for that purpose, to verify that it is the same or less than the overall system response time specified by the machine manufacturer.
15. If the Ethernet cable is removed, lower the attached cover tightly into place.

Do not continue operation until the entire checkout procedure is complete and all problems are corrected.



WARNING:

- Do not use the machine until the system is working properly.
- Attempts to use the guarded machine if these checks cannot be verified could result in serious injury or death.
- If all these checks cannot be verified, do not attempt to use or operate the machine until the defect or problem has been corrected.

8.4 Daily Checkout Procedure

Perform the Daily Checkout procedure at every shift change, power-up, and machine set-up change – and at intervals not to exceed 24 hours during continuous machine run periods. Record a copy of the checkout results and store in the appropriate place (e.g., near or on the machine, in the machine’s technical file).

Tester: Designated Person or Qualified Person.

Refer to the procedure contained on the Daily Checkout card (Banner p/n [208912](#)) downloaded from www.bannerengineering.com. Print out the instructions to be posted near the installation/guarded machine, for easy reference.

8.5 Semi-Annual Checkout Procedure

Perform the Semi-Annual Checkout procedure every six months following system installation, or whenever changes are made to the SX5 configuration or to the machine. A copy of checkout results should be recorded and kept in the appropriate place (e.g., near or on the machine, in the machine's technical file).

Tester: Qualified Person.

Refer to the procedure contained on the Semi-Annual Checkout card (Banner p/n [208911](#)) downloaded from www.bannerengineering.com. Print out the instructions to be posted near the installation/guarded machine, for easy reference.

9 Troubleshooting

9.1 Initial Troubleshooting Steps

The SX5 uses three diagnostics levels to quickly resolve errors. Follow these steps to resolve an error.



WARNING:

- Remove power from the machinery before servicing it.
- Servicing the SX5 while the hazardous machinery is operational could result in serious injury or death.
- The machinery to which the Scanner is connected must not be operating at any time during major service or maintenance. This may require lockout/tagout procedures (refer to OSHA1910.147, ANSI Z244-1, or the appropriate standard for controlling hazardous energy).

1. Determine the SX5’s status, signaled via LEDs and the Diagnostic Display.
2. Remove the errors with the specified measures listed in the diagnostic key.

9.2 Troubleshooting Lockout Conditions



WARNING:

- Power failures and Lockout conditions indicate a problem
- Attempts to continue to operate machinery by bypassing the SX5 or other safeguards is dangerous and could result in serious injury or death.
- Power failures and Lockout conditions indicate a problem and must be investigated immediately by a Qualified Person.





A Lockout condition causes all the SX5 OSSD outputs to turn or remain off, sending a stop signal to the guarded machine. Diagnostic error codes are available to assist in the identification of the cause(s) of lockouts.





The SX5 provides easy methods for determining operating problems. The Lockout condition is indicated by the display showing a red box with a symbol and error code listed in it.

To recover from a Lockout condition:





1. Correct all errors.
2. Perform the reset routine or cycle power to the SX5 (power the SX5 down, wait five to 10 seconds, then power it up).





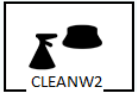

9.3 Display Icons



Configuration Accepted	Configuration Not Accepted	Name	Description
		Device On	The device is correctly functioning. No objects are detected in the Warning Zone or Safety Zone.
		Warning Zone Signal	The device is correctly functioning. The device has detected an object in the Warning Zone.

Configuration Accepted	Configuration Not Accepted	Name	Description
		Safety Zone Signal	The device is correctly functioning. The device has detected an object in the Safety Zone.
		Reference Point Signal	Reference points have moved. The display sector in the direction of the moved point is shown in blue.

9.4 Diagnostic Notes, Warnings, and Errors

Icon	Fault Code	Device Status	OSSD Status	Description
	DLDNF	Normal	Off	Downloading the new firmware.
	DLDNC	Normal	Off	Downloading the new configuration.
	CLEANW2	Normal	On	Clean the window to avoid a lockout condition.
	ITLOCK1	Normal	Off	Interlock; waiting for a restart signal to turn the OSSDs back on.
	INTF6	Normal	On	Non-safety related internal test failure. Reset the system using the reset function or cycle the power to the device. If the failure persists, contact the factory for support.
	EXTTEMP	Normal	On	The device is operating in an environment that exceeds the specified operating temperature range. Restore the correct ambient temperature conditions.
	BOOTF	Normal	Off	Invalid boot. Re-boot the system until the normal condition is restored. If warning persists, contact the factory for support.

Icon	Fault Code	Device Status	OSSD Status	Description
	MUT TIMEOUT	Normal	On	Muting has expired because it is maintained beyond the maximum timeout time.
	MUTING ERR	Normal	On	Muting has not activated because the correct sequence was not followed.
	MUTING	Normal	On	The Muting function is active.
	OVERRIDE ERR	Normal	On	Override has not been activated because the correct sequence has not been followed or there are no override conditions.
	OVERRIDE	Normal	On	The Override function is active.
	OVERTEMP	Normal	On	The unit is operating above or below its allowed operating temperature range.
	OVR TIMEOUT	Normal	On	The Override timeout function has expired.
	CLEANW1	Normal	Off	Clean the window until the normal condition is restored. If cleaning the window does not restore the device to a normal condition, replace the damaged scanner. Contact the factory for support.
	INPUTCF1	Lockout	Off	Check the input connection or sequence.

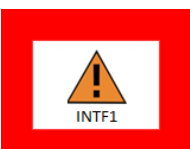
Icon	Fault Code	Device Status	OSSD Status	Description
	INPUTCF2	Lockout	Off	Check the input sequence.
	OSSDF1	Lockout	Off	Check the OSSD connections or the integrity of the external switching device. If the failure persists, contact the factory for support.
	OSSD1F3	Lockout	Off	A short circuit to ground (GND) has been detected. Check the OSSD connections or the integrity of the external switching device. If the failure persists, contact the factory for support.
	INTF1-20	Lockout	Off	Internal Failure. Reset the system using the reset function or cycle power to the device. If the failure persists, contact the factory for support.

9.5 Safety



WARNING:

- **If the device is not working properly, personnel may not be detected.**
- Failure to follow these instructions could result in serious injury or death.
- Stop the machine operation if the machine behaves unpredictably or if the behavior cannot be identified.
- Stop the machine operation if you cannot identify or locate the fault or you cannot correct the fault.
- Secure the machine so that it cannot be unintentionally turned on.



WARNING:

- **Do not start up the machine unexpectedly.**
- Failure to follow these instructions could result in serious injury or death.
- When any work is taking place, use the protective device to secure the machine or to ensure that the machine is not switched on unintentionally.



WARNING:

- **If the device is not working properly, personnel may not be detected.**
- Failure to follow these instructions could result in serious injury or death.
- Do not attempt to repair the device components.
- Do not make any changes to or tamper with the device components.
- With the exception of the procedures described in this document, the device components must not be opened.



Important: If you cannot remedy the fault with the help of the information provided in this chapter, please contact the factory.

9.6 Check for Sources of Electrical and Optical Noise

The SX5 is designed and manufactured to be highly resistant to electrical and optical noise and to operate reliably in industrial settings. However, serious electrical and/or optical noise may cause a random OFF state of the OSSDs. In very extreme electrical noise cases, a Lockout is possible.

Do not directly ground the SX5 housing. Make only those connections as described in this document.

All SX5 wiring is low voltage. Running these wires alongside power wires, motor/servo wires, or other high-voltage wiring can inject noise into the SX5. It is good wiring practice (and may be required by code) to isolate SX5 wires from high-voltage wires. The Banner model BT-1 Beam Tracker (see Banner catalog or website) is a very good tool for detecting electrical noise. It can be used to detect electrical transient spikes and surges.

If random nuisance noise problems occur:



1. Check for optical interference from adjacent safety laser scanners or other photoelectric sensors.
 - a) Turn off the Scanner.
 - b) Use a Banner BT-1 Beam Tracker to check for light at the SX5 front screen (window) by press the RCV button on the BT-1 and moving across the full length of the window with the BT-1 lenses facing away from the SX5.
 - c) If the BT-1's indicator lights up, check for light from other sources (e.g., other safety laser scanners) by tracking down the emitted light using the BT-1.
2. Check for sources of electrical noise.
 - a) Turn off the Scanner.
 - b) Cover the lens of the BT-1 with electrical tape to block optical light from getting into the receiver lens.
 - c) Press the RCV button on the BT-1 and position the Beam Tracker on the wires going to the Scanner or any other nearby wires.
 - d) To reduce or eliminate noise caused by the switching of inductive loads, install proper transient suppression across the load.

10 Accessories

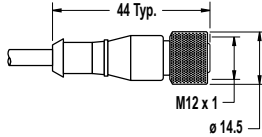
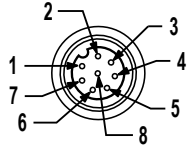
10.1 Cordsets

8-Pin Threaded M12/Euro-Style to Flying Lead Cordsets for the SX5-B				
Model	Length	Style	Dimensions	Pinout (Female)
SXA-815D	4.57 m (15 ft)	Straight		
SXA-825D	7.62 m (25 ft)			
SXA-850D	15.2 m (50 ft)			
SXA-8100D	30 m (100 ft)			

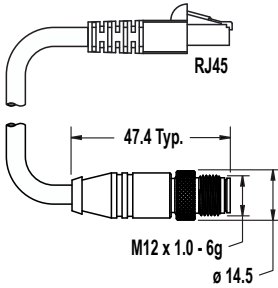
1 = White 5 = Gray
 2 = Brown 6 = Pink
 3 = Green 7 = Blue
 4 = Yellow 8 = Red

4-pin M12/Euro-style D-code to RJ45 Shielded Ethernet				
Model	Length	Style	Dimensions	Pinout (Male)
STP-M12D-406	1.83 m (6 ft)	Straight		
STP-M12D-415	4.57 m (15 ft)			
STP-M12D-430	9.14 m (30 ft)			

1 = White/Orange 1 = White/Orange
 2 = Orange 2 = White/Blue
 3 = White/Blue 3 = Orange
 6 = Blue 4 = Blue

10.2 Brackets

SXA-MBK-2

- Protection Bracket
-

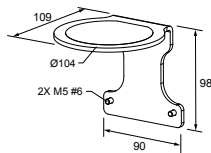

SXA-MBK-1

- Pitch and Roll Angle Adjustment Bracket
-

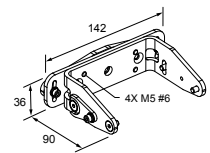

10.3 Other Accessories

Model	Description
AG4-CLN1	Cleaning kit—150 mls approved fluid for cleaning plastic, 25 soft lint-free cleaning cloths

Model	Description
AG4-CLN2	Cleaning kit—1000 mls approved fluid for cleaning plastic, 100 soft lint-free cleaning cloths

10.4 Universal (Input) Safety Modules

UM-FA-xA Safety Modules provide forced-guided, mechanically-linked relay (safety) outputs for the SX5 system when an external manual reset (latch) is desired by the application. See datasheet p/n [141249](#) for more information.

Model	Description
UM-FA-9A	3 normally open (N.O.) redundant-output 6 amp contacts
UM-FA-11A	2 normally open (N.O.) redundant-output 6 amp contacts, plus 1 normally closed (N.C.) auxiliary contact

10.5 Safety Controllers

Safety Controllers provide a fully configurable, software-based safety logic solution for monitoring safety and non-safety devices. For additional models and XS26 expansion modules, see instruction manuals p/n [174868](#) (XS/SC26-2) and [133487](#) (SC22-3).

Non-Expandable Models	Expandable Models	Description
SC26-2	XS26-2	26 convertible I/O and 2 Redundant Solid State Safety Outputs
SC26-2d	XS26-2d	26 convertible I/O and 2 Redundant Solid State Safety Outputs with Display
SC26-2e	XS26-2e	26 convertible I/O and 2 Redundant Solid State Safety Outputs with Ethernet
SC26-2de	XS26-2de	26 convertible I/O and 2 Redundant Solid State Safety Outputs with Display and Ethernet

Model	Description
SC22-3-S	22 safety inputs, 10 Auxiliary Outputs, 3 Redundant Solid State safety Outputs with display
SC22-3-SU1	22 safety inputs, 10 Auxiliary Outputs, 3 Redundant Solid State safety Outputs with display (includes programming tool and USB cable)
SC22-3E-S	22 safety inputs, 10 Auxiliary Outputs, 3 Redundant Solid State safety Outputs with display and Ethernet
SC22-3E-SU1	22 safety inputs, 10 Auxiliary Outputs, 3 Redundant Solid State safety Outputs with display and Ethernet (includes programming tool and USB cable)

10.6 Interface Modules

IM-T-..A interface modules provide forced-guided, mechanically-linked relay (safety) outputs for the SX5 system with the Manual Reset function configured. The IM-T-..A interface module is required to be monitored by the EDM function (performed by the reset line). See Banner datasheet p/n [62822](#) for more information.

Model	Description
IM-T-9A	Interface module, 3 normally open (N.O.) redundant-output 6 amp contacts
IM-T-11A	Interface module, 2 normally open (N.O.) redundant-output 6 amp contacts, plus 1 normally closed (N.C.) auxiliary contact

10.7 Contactors

If used, two contactors per SX5 system that are monitored by the EDM circuit (performed by the reset line) are required. See Banner datasheet p/n [111881](#) for more information.

Model	Description
11-BG00-31-D-024	10 amp positive-guided contactor, 3 N.O., 1 N.C.
BF1801L024	18 amp positive-guided contactor, 3 N.O., 1 N.C. (N.C. contact rated at 10 amps)

11 Product Support and Maintenance

11.1 Update the Firmware

1. Download the updated firmware from Banner Engineering's website.
2. Launch the SX5soft software.
3. Select **New Configuration**.
4. Enter **Discovery** mode and select an online scanner.
5. Click **Scanner** on the menu and choose the firmware update option.
6. Enter the device password (default password is `admin`).
7. In the Firmware update (Package) section, click on **ZIP Archive** to search for and select the downloaded firmware.
8. Click **Load** (Configuration Upload).
During the firmware update, the device is offline.
9. After the firmware loads, enter **Offline-Test** mode to create a configuration and test the new firmware.
10. If the firmware is compatible with the device (the configuration is correct with no failures), click **Accept** (Validation). If the firmware is not compatible, click **Reject**.

11.2 Handing the Scanner

Observe the permissible environmental conditions for storage and operation. The Scanner's front screen must be clean, free of damage, and properly installed.

- Avoid touching the front screen.
- Clean dirty screens immediately.

The SX5's IP protection is guaranteed only when M12 cables or dust covers are installed on the connectors. Only operate, transport, and store the scanner with its installed cables or dust covers.

11.3 Cleaning the Screens

Clean the SX5's front and scatter screens regularly, at a frequency depending on the surrounding environmental conditions, and using the recommended materials. Use only the cleaning kit specified, consisting of approved cleanser and cleaning cloths.

Do not use scouring pads or cloths that can cause scratching (e.g., paper towels). Never use solvents that can damage the plastic materials. The cleaning procedure depends on the type and degree of contamination.

Contamination	Cleaning Method
Particles, loose, scouring	Vacuum without touching or blow away softly, oil-free; or wipe free in one swipe with cleaning cloth
Particles, loose, non-scouring	Vacuum without touching or blow away softly; or wipe free in one swipe with cleaning cloth
Particles, sticking	Wet with cloth soaked in cleanser; or wipe free in one swipe with cleaning cloth
Particles, statically charged	Vacuum without touching; or wipe free in one swipe with cleaning cloth soaked with cleanser
Particles/drops, smearing	Wet with cloth soaked in cleanser and wipe free in one swipe with cleaning cloth
Water drops	Wipe free in one swipe with cleaning cloth
Oil drops	Wet with cloth soaked in cleanser and wipe free in one swipe with cleaning cloth
Fingerprints	Wet with cloth soaked in cleanser and wipe free in one swipe with cleaning cloth

11.4 Replace Your Scanner

If it is necessary to replace your SX5, replace the SX5 with the same model and install it in the same position and alignment as the original SX5.

1. Remove all power from the SX5 and the guarded machine.

2. Remove the original SX5.
3. Mount the replacement SX5 using the existing mounting bracket or holes.
4. Verify the alignment of the new SX5 (e.g., tilt and rotation) matches that of the original SX5.
5. Connect the 8-pin M12/Euro-Style pigtail to the machine interface cable.
6. Connect a 4-pin M12/Euro-Style Ethernet cable to the Ethernet port and transfer the appropriate configuration from a saved file or create a new configuration.
7. Apply power to only the SX5 (not the machine) and perform the Commissioning Checkout procedure.

11.5 Repairs

Contact Banner Engineering for troubleshooting of this device. **Do not attempt any repairs to this Banner device; it contains no field-replaceable parts or components.** If the device, device part, or device component is determined to be defective by a Banner Applications Engineer, they will advise you of Banner's RMA (Return Merchandise Authorization) procedure.



Important: If instructed to return the device, pack it with care. Damage that occurs in return shipping is not covered by warranty.

11.6 Contact Us

Banner Engineering Corporate headquarters is located at:

9714 Tenth Avenue North
 Minneapolis, MN 55441, USA
 Website: www.bannerengineering.com
 Phone: + 1 888 373 6767

For worldwide locations and local representatives, visit www.bannerengineering.com.

11.7 Banner Engineering Corp Limited Warranty

Banner Engineering Corp. warrants its products to be free from defects in material and workmanship for one year following the date of shipment. Banner Engineering Corp. will repair or replace, free of charge, any product of its manufacture which, at the time it is returned to the factory, is found to have been defective during the warranty period. This warranty does not cover damage or liability for misuse, abuse, or the improper application or installation of the Banner product.

THIS LIMITED WARRANTY IS EXCLUSIVE AND IN LIEU OF ALL OTHER WARRANTIES WHETHER EXPRESS OR IMPLIED (INCLUDING, WITHOUT LIMITATION, ANY WARRANTY OF MERCHANTABILITY OR FITNESS FOR A PARTICULAR PURPOSE), AND WHETHER ARISING UNDER COURSE OF PERFORMANCE, COURSE OF DEALING OR TRADE USAGE.

This Warranty is exclusive and limited to repair or, at the discretion of Banner Engineering Corp., replacement. **IN NO EVENT SHALL BANNER ENGINEERING CORP. BE LIABLE TO BUYER OR ANY OTHER PERSON OR ENTITY FOR ANY EXTRA COSTS, EXPENSES, LOSSES, LOSS OF PROFITS, OR ANY INCIDENTAL, CONSEQUENTIAL OR SPECIAL DAMAGES RESULTING FROM ANY PRODUCT DEFECT OR FROM THE USE OR INABILITY TO USE THE PRODUCT, WHETHER ARISING IN CONTRACT OR WARRANTY, STATUTE, TORT, STRICT LIABILITY, NEGLIGENCE, OR OTHERWISE.**

Banner Engineering Corp. reserves the right to change, modify or improve the design of the product without assuming any obligations or liabilities relating to any product previously manufactured by Banner Engineering Corp. Any misuse, abuse, or improper application or installation of this product or use of the product for personal protection applications when the product is identified as not intended for such purposes will void the product warranty. Any modifications to this product without prior express approval by Banner Engineering Corp will void the product warranties. All specifications published in this document are subject to change; Banner reserves the right to modify product specifications or update documentation at any time. Specifications and product information in English supersede that which is provided in any other language. For the most recent version of any documentation, refer to: www.bannerengineering.com.

For patent information, see www.bannerengineering.com/patents.

12 Standards and Regulations

The list of standards below is included as a convenience for users of this Banner device. Inclusion of the standards below does not imply that the device complies specifically with any standard, other than those specified in the Specifications section of this manual.

12.1 Applicable U.S. Standards

ANSI B11.0 Safety of Machinery, General Requirements, and Risk Assessment	ANSI B11.15 Pipe, Tube, and Shape Bending Machines
ANSI B11.1 Mechanical Power Presses	ANSI B11.16 Metal Powder Compacting Presses
ANSI B11.2 Hydraulic Power Presses	ANSI B11.17 Horizontal Extrusion Presses
ANSI B11.3 Power Press Brakes	ANSI B11.18 Machinery and Machine Systems for the Processing of Coiled Strip, Sheet, and Plate
ANSI B11.4 Shears	ANSI B11.19 Performance Criteria for Safeguarding
ANSI B11.5 Iron Workers	ANSI B11.20 Manufacturing Systems
ANSI B11.6 Lathes	ANSI B11.21 Machine Tools Using Lasers
ANSI B11.7 Cold Headers and Cold Formers	ANSI B11.22 Numerically Controlled Turning Machines
ANSI B11.8 Drilling, Milling, and Boring	ANSI B11.23 Machining Centers
ANSI B11.9 Grinding Machines	ANSI B11.24 Transfer Machines
ANSI B11.10 Metal Sawing Machines	ANSI/RIA R15.06 Safety Requirements for Industrial Robots and Robot Systems
ANSI B11.11 Gear Cutting Machines	ANSI NFPA 79 Electrical Standard for Industrial Machinery
ANSI B11.12 Roll Forming and Roll Bending Machines	ANSI/PMMI B155.1 Package Machinery and Packaging-Related Converting Machinery — Safety Requirements
ANSI B11.13 Single- and Multiple-Spindle Automatic Bar and Chucking Machines	
ANSI B11.14 Coil Slitting Machines	

12.2 Applicable OSHA Regulations

OSHA Documents listed are part of: Code of Federal Regulations Title 29, Parts 1900 to 1910

OSHA 29 CFR 1910.212 General Requirements for (Guarding of) All Machines

OSHA 29 CFR 1910.147 The Control of Hazardous Energy (lockout/tagout)

OSHA 29 CFR 1910.217 (Guarding of) Mechanical Power Presses

12.3 International/European Standards

EN ISO 12100 Safety of Machinery – General Principles for Design – Risk Assessment and Risk Reduction

ISO 13857 Safety Distances . . . Upper and Lower Limbs

ISO 13850 (EN 418) Emergency Stop Devices, Functional Aspects – Principles for Design

EN 574 Two-Hand Control Devices – Functional Aspects – Principles for Design

IEC 62061 Functional Safety of Safety-Related Electrical, Electronic and Programmable Control Systems

EN ISO 13849-1 Safety-Related Parts of Control Systems

EN 13855 (EN 999) The Positioning of Protective Equipment in Respect to Approach Speeds of Parts of the Human Body

ISO 14119 (EN 1088) Interlocking Devices Associated with Guards – Principles for Design and Selection

EN 60204-1 Electrical Equipment of Machines Part 1: General Requirements

IEC 61496 Electro-sensitive Protection Equipment

IEC 60529 Degrees of Protection Provided by Enclosures

IEC 60947-1 Low Voltage Switchgear – General Rules

IEC 60947-5-1 Low Voltage Switchgear – Electromechanical Control Circuit Devices

IEC 60947-5-5 Low Voltage Switchgear – Electrical Emergency Stop Device with Mechanical Latching Function

IEC 61508 Functional Safety of Electrical/Electronic/Programmable Electronic Safety-Related Systems

IEC 62046 Safety of Machinery – Applications of Protective Equipment to Detect the Presence of Persons

13 Glossary

A

ANSI (American National Standards Institute)

Acronym for the American National Standards Institute, an association of industry representatives that develops technical standards (including safety standards). These standards comprise a consensus from a variety of industries on good practice and design. ANSI standards relevant to application of safety products include the ANSI B11 Series, and ANSI/RIA R15.06. See [Standards and Regulations](#) on page 92.

Auto Power-Up

A safety light screen system feature that enables the system to be powered up into Run mode (or recover from a power interruption) without requiring a manual reset.

Auto Start/Restart (Trip) Condition

The safety outputs of a safety light screen system turn off when an object completely blocks a beam. In an Auto Start/Restart condition, the safety outputs re-energize when the object is removed from the defined area.

Auto Start/Restart (Trip) Initiate

The resetting of a safeguard causing the initiation of machine motion or operation. Auto Start/Restart Initiate is not allowed as a means to initiate a machine cycle per NFPA 79 and ISO 60204-1, and is commonly confused with PSDI.

B

Blanking

A programmable feature of a safety light screen system which allows the light screen to ignore certain objects located within the defined area. See **Floating Blanking** and **Reduced Resolution**.

Blocked Condition

A condition that occurs when an opaque object of sufficient size blocks/interrupts one or more light screen beams. When a blocked condition occurs, OSSD1 and OSSD2 outputs simultaneously turn off within the system response time.

Brake

A mechanism for stopping, slowing, or preventing motion.

C

Cascade

Series connection (or "daisy-chaining") of multiple emitters and receivers.

CE

Abbreviation for "Conformité Européenne" (French translation of "European Conformity"). The CE mark on a product or machine establishes its compliance with all relevant European Union (EU) Directives and the associated safety standards.

Clutch

A mechanism that, when engaged, transmits torque to impart motion from a driving member to a driven member.

Control Reliability

A method of ensuring the performance integrity of a control system or device. Control circuits are designed and constructed so that a single failure or fault within the system does not prevent the normal stopping action from being applied to the machine when required, or does not create unintended machine action, but does prevent initiation of successive machine action until the failure is corrected.

CSA

Abbreviation for Canadian Standards Association, a testing agency similar to Underwriters Laboratories, Inc. (UL) in the United States. A CSA-certified product has been type-tested and approved by the Canadian Standards Association as meeting electrical and safety codes.

D

Defined Area

The "screen of light" generated by a safety light screen system, defined by the height and the safety distance (minimum distance) of the system.

Designated Person

A person or persons identified and designated in writing, by the employer, as being appropriately trained and qualified to perform a specified checkout procedure.

E

Emitter

The light-emitting component of a safety light screen system, consisting of a row of synchronized modulated LEDs. The emitter, together with the receiver (placed opposite), creates a "screen of light" called the defined area.

External Device Monitoring (EDM)

A means by which a safety device (such as a safety light screen) actively monitors the state (or status) of external devices that may be controlled by the safety device. A lockout of the safety device will result if an unsafe state is detected in the external device. External device(s) may include, but are not limited to: MPCEs, captive contact relays/contactors, and safety modules.

F

Failure to Danger

A failure which delays or prevents a machine safety system from arresting dangerous machine motion, thereby increasing risk to personnel.

Final Switching Device (FSD)

The component of the machine's safety-related control system that interrupts the circuit to the machine primary control element (MPCE) when the output signal switching device (OSSD) goes to the OFF-state.

FMEA (Failure Mode and Effects Analysis)

A testing procedure by which potential failure modes in a system are analyzed to determine their results or effects on the system. Component failure modes that produce either no effect or a Lockout condition are permitted; failures which cause an unsafe condition (a failure to danger) are not. Banner safety products are extensively FMEA tested.

G

Guarded Machine

The machine whose point of operation is guarded by the safety system.

H

Hard (Fixed) Guard

Screens, bars, or other mechanical barriers affixed to the frame of the machine intended to prevent entry by personnel into the hazardous area(s) of a machine, while allowing the point of operation to be viewed. The maximum size of the openings is determined by the applicable standard, such as Table O-10 of OSHA 29CFR1910.217, also called a "fixed barrier guard."

Harm

Physical injury or damage to the health of people, which may result through direct interaction with the machine or through indirect means, as a result of damage to property or to the environment.

Hazard Point

The closest reachable point of the hazardous area.

Hazardous Area

An area that poses an immediate or impending physical hazard.

I

Internal Lockout

A Lockout condition that is due to an internal safety system problem. Generally, indicated by the red Status indicator LED (only) flashing. Requires the attention of a Qualified Person.

K

Key Reset (Manual Reset)

A key-operated switch used to reset a safety light screen system to RUN mode following a Lockout condition. Also refers to the act of using the switch.

L

Lockout Condition

A safety light screen condition that is automatically attained in response to certain failure signals (an internal lockout). When a Lockout condition occurs, the safety light screen's safety outputs turn Off; the failure must be corrected and a manual reset is required to return the system to Run mode.

M

Machine Primary Control Element (MPCE)

An electrically powered element, external to the safety system, which directly controls the machine's normal operating motion in such a way that the element is last (in time) to operate when machine motion is either initiated or arrested.

Machine Response Time

The time between the activation of a machine stopping device and the instant when the dangerous parts of the machine reach a safe state by being brought to rest.

Manual Start/Restart (Latch) Condition

The safety outputs of a safety light screen system turn off when an object completely blocks a beam. In a Manual Start/Restart condition, the safety outputs stay off when the object is removed from the defined area. To re-energize the outputs, perform a proper manual reset.

Minimum Object Sensitivity (MOS)

The minimum-diameter object that a safety light screen system can reliably detect. Objects of this diameter or greater will be detected anywhere in the defined area. A smaller object can pass undetected through the light if it passes exactly midway between two adjacent light beams. Also known as MODS (Minimum Object Detection Size). See also **Specified Test Piece**.

Muting

The automatic suspension of the safeguarding function of a safety device during a non-hazardous portion of the machine cycle.

O

Off State

The state in which the output circuit is interrupted and does not permit the flow of current.

On State

The state in which the output circuit is complete and permits the flow of current.

OSHA (Occupational Safety and Health Administration)

A U.S. Federal agency, Division of the U.S. Department of Labor, that is responsible for the regulation of workplace safety.

OSSD

Output Signal Switching Device. The safety outputs that are used to initiate a stop signal.

P

Part-Revolution Clutch

A type of clutch that may be engaged or disengaged during the machine cycle. Part-revolution clutched machines use a clutch/brake mechanism, which can arrest machine motion at any point in the stroke or cycle.

Pass-Through Hazard

A pass-through hazard is associated with applications where personnel may pass through a safeguard (which issues a stop command to remove the hazard), and then continues into the guarded area, such as in perimeter guarding. Subsequently, their presence is no longer detected, and the related danger becomes the unexpected start or restart of the machine while personnel are within the guarded area.

Point of Operation

The location of a machine where material or a workpiece is positioned and a machine function is performed upon it.

PSDI (Presence-Sensing Device Initiation)

An application in which a presence-sensing device is used to actually start the cycle of a machine. In a typical situation, an operator manually positions a part in the machine for the operation. When the operator moves out of the danger area, the presence sensing device starts the machine (no start switch is used). The machine cycle runs to completion, and the operator can then insert a new part and start another cycle. The presence sensing device continually guards the machine. Single-break mode is used when the part is automatically ejected after the machine operation. Double-break mode is used when the part is both inserted (to begin the operation) and removed (after the operation) by the operator. PSDI is commonly confused with "Trip Initiate." PSDI is defined in OSHA CFR1910.217. Banner safety light screen systems may not be used as PSDI devices on mechanical power presses, per OSHA regulation 29 CFR 1910.217.

Q

Qualified Person

A person who, by possession of a recognized degree or certificate of professional training, or who, by extensive knowledge, training and experience, has successfully demonstrated the ability to solve problems relating to the subject matter and work.

R

Receiver

The light-receiving component of a safety light screen system, consisting of a row of synchronized phototransistors. The receiver, together with the emitter (placed opposite), creates a "screen of light" called the defined area.

Reset

The use of a manually operated switch to restore the safety outputs to the On state from a lockout condition.

Resolution

See **Minimum Object Sensitivity**.

S

Self-Checking (Circuitry)

A circuit with the capability to electronically verify that all of its own critical circuit components, along with their redundant backups, are operating properly. Banner safety light screen systems and safety modules are self-checking.

Safety Distance

The minimum distance required to allow the machine's hazardous motion to stop completely, before a hand (or other object) can reach the nearest hazard point. Measured from the midpoint of the defined area to the nearest hazard point. Factors that influence minimum separation distance include the machine stop time, the light screen system response time, and the light screen minimum object detection size.

Specified Test Piece

An opaque object of sufficient size used to block a light beam to test the operation of a safety light screen system. When inserted into the defined area and placed in front of a beam, the test piece causes the outputs to de-energize.

Supplemental Guarding

Additional safeguarding device(s) or hard guarding, used to prevent a person from reaching over, under, through or around the primary safeguard or otherwise accessing the guarded hazard.

T

Test Piece

An opaque object of sufficient size used to block a light beam to test the operation of a safety light screen system.

U

UL (Underwriters Laboratory)

A third-party organization that tests products for compliance with appropriate standards, electrical codes, and safety codes. Compliance is indicated by the UL listing mark on the product.