

TURCK

Your Global Automation Partner

Connection Technology for Mobile Equipment

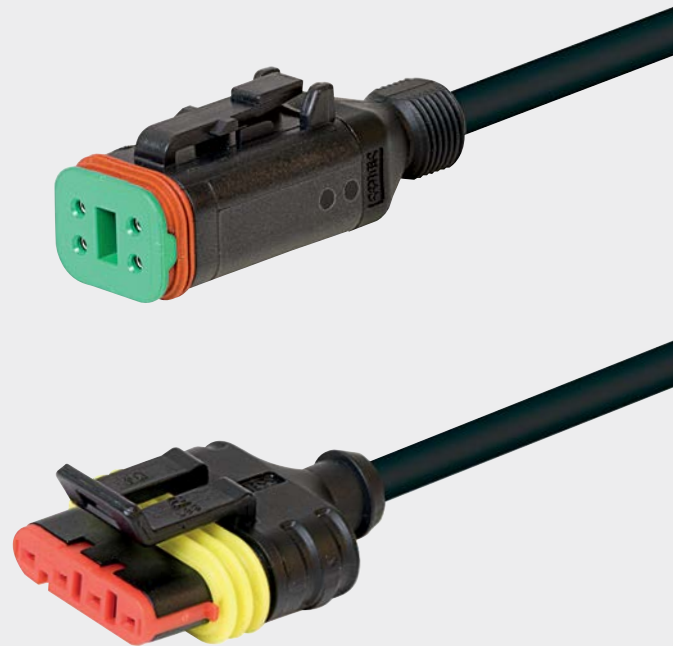

Products are linked with further information.

Connection Technology for Mobile Equipment

Robust solutions for standard and special applications

Regardless of whether it's a construction machine, agricultural machine or mobile crane, mobile equipment is often used in extreme environmental conditions. In cold or hot weather, snow, rain or intense sunlight, machines must ensure fail-safe operation. Even severe vibration and shock must be no match for the machine.

Robust solutions from professionals

Compared to standard automation applications, mobile devices require even more robust solutions. This not only goes for the sensors and actuators, but also for the connection technology. Besides a broad range of sensors, industrial connectors and cables, TURCK, as one of the world's leading suppliers of automation solutions, offers its customers special variants, for which even the harshest application requirements are no match.

TURCK has thus developed the two DT and TSS connection technology series, which are specially tailored to the special requirements of mobile equipment.

Protection from humidity

Thanks to overmolded grip bodies and the use of silicon seals, the DT and TSS series can provide protection to IP67 and IP69K. While IP67 refers to immersion for 30 minutes in one meter of water at room temperature, the tests for IP69K ensure that the devices are protected from the effect of high pressure and steam cleaning as is usually performed on vehicles.

Besides the use of robust and durable plastic, TURCK also ensures the highest standard of quality for all internal features: The DT and TSS series were therefore fitted exclusively with contacts from Tyco Electronics (TE).



Temperature resistance

- temperature resistance -40...+85 °C
- extreme application areas
- mounting possible near engine

Material properties

- made entirely from durable TPU (thermoplastic polyurethane)
- good chemical resistance
- halogen-free and flame-retardant

LED and suppression circuit

- status indication on connector through translucent overmold
- overvoltage protection

Thread for protective tube

- easy mounting of protective tubes through premolded thread on grip body
- additional protection from humidity, mechanical and chemical damage

Approvals

- RoHS
- halogen-free according to DIN VDE 0472 Part 815
- flame retardant according to cULus 20549

Customized solutions

- variable cable lengths
- different number of pins
- multiple junctions
- connector chains
- power and bus supply

DT series

- up to 12-pin
- improved component protection through suppressor circuit for pin numbers 2 and 3
- integrated LED

TSS series

- up to 6-pin
- compact
- very economical



	DT series	TSS series
Connectors	Deutsch	Superseal
Jacket material	TPE-U (PUR)	TPE-U (PUR)
Jacket color	Black	Black
Core cross-section	0.75 mm ² /AWG 18	0.75 mm ² /AWG 18
Braid arrangement	42 x 0.15 mm	42 x 0.15 mm
Rated voltage	12/24 VAC/DC	12/24 VAC/DC
Current carrying capacity	8A at 40 °C (2-, 3-pin.) 7A at 40 °C (4-pin.) 6A at 40 °C (6-, 8-pin.) 5A at 40 °C (12-pin)	8A at 40 °C (2-, 3-pin.) 7A at 40 °C (4-, 5-pin.) 6A at 40 °C (6-pin)
Suitable for drag chain use	Yes	Yes
Ambient temperature fixed	-40...+80 °C	-40...+80 °C
Ambient temperature moving	-25...+80 °C	-25...+80 °C
RoHS-compliant	Yes	Yes
Flame retardant acc. to	cUlus 20549	cUlus 20549
Halogen-free acc. to	DIN VDE 0472 Part 815	DIN VDE 0472 Part 815
Degree of protection when connected	IP67/IP69K	IP67/IP69K
Suppressor circuit suppressor diode with pin numbers	2 and 3	no



Deutsch Connectors – DT Series

Solutions for every application

The Deutsch DT connector series from TURCK offers high quality prefabricated and overmolded cables. These meet all requirements in terms of sealing and mechanical strength for the fail-safe implementation of your specific wiring concepts.

With the large range of possible pin numbers, with optional LED and suppressor circuit, the Deutsch connector series covers a host of different application possibilities.

Essential features of the DT series:

- made entirely from durable TPU (thermoplastic polyurethane)
- temperature resistance -40...+85 °C
- high sealing capacity thanks to silicon seals to IP67/IP69K
- male thread for mounting protective tube
- suppressor circuit, suppressor diode, 2 x LEDs yellow
- overmolded cables
- halogen-free and flame-retardant



Type Code Deutsch DT Series

DT 06 - 2 S G - A - 5 / TXL

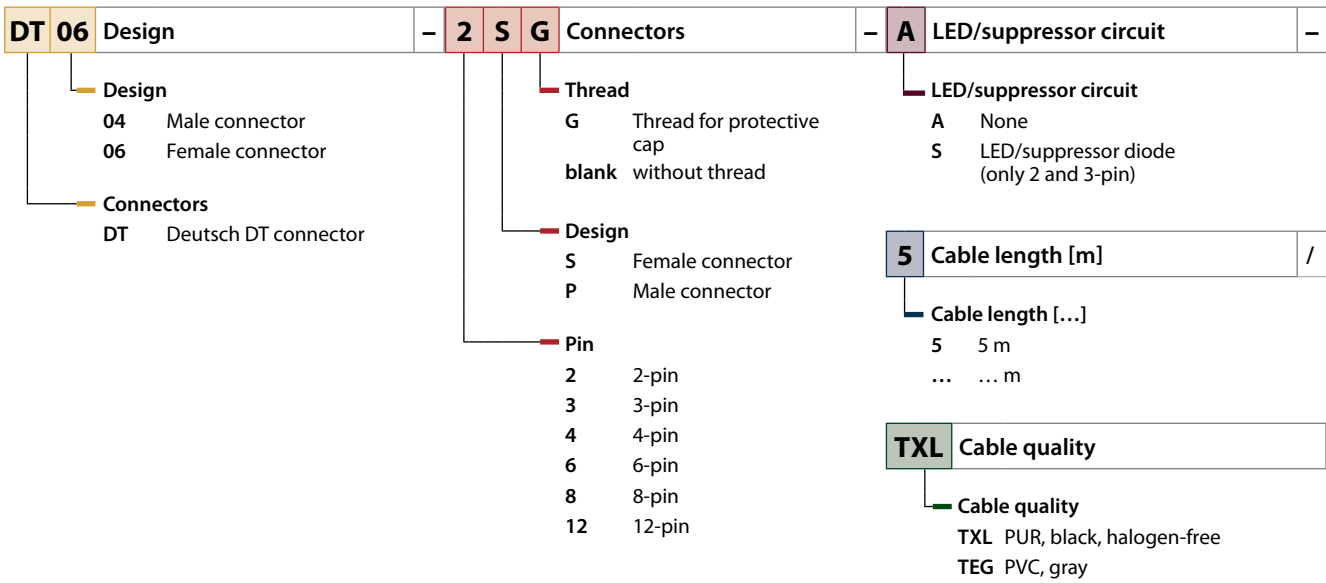

Deutsch Connectors – DT Series

Type code	ID	Connector S = Female P = Male	Number of pins/ Number of wires	Cable length	LED/suppressor circuit	Protective tube thread	Stock item	
	DT06-2S-S-2/TXL	6936700	S	2	2 m	●	-	-
	DT06-2S-S-5/TXL	6936701	S	2	5 m	●	-	-
	DT06-2S-S-10/TXL	6936702	S	2	10 m	●	-	-
	DT06-2S-A-2/TXL	6936706	S	2	2 m	-	-	●
	DT06-2S-A-5/TXL	6936707	S	2	5 m	-	-	-
	DT06-2S-A-10/TXL	6936708	S	2	10 m	-	-	●
	DT06-2SG-S-2/TXL	6936703	S	2	2 m	●	●	●
	DT06-2SG-S-5/TXL	6936704	S	2	5 m	●	●	-
	DT06-2SG-S-10/TXL	6936705	S	2	10 m	●	●	●
	DT06-2SG-A-2/TXL	6936709	S	2	2 m	-	●	-
	DT06-2SG-A-5/TXL	6936710	S	2	5 m	-	●	-
	DT06-2SG-A-10/TXL	6936711	S	2	10 m	-	●	-
	DT04-2P-S-2/TXL	100000243	P	2	2 m	●	-	-
	DT04-2P-S-5/TXL	100000244	P	2	5 m	●	-	-
	DT04-2P-S-10/TXL	100000245	P	2	10 m	●	-	-
	DT04-2P-A-2/TXL	100000249	P	2	2 m	-	-	●
	DT04-2P-A-5/TXL	100000386	P	2	5 m	-	-	-
	DT04-2P-A-10/TXL	100000387	P	2	10 m	-	-	●
	DT04-2PG-S-2/TXL	100000246	P	2	2 m	●	●	●
	DT04-2PG-S-5/TXL	100000247	P	2	5 m	●	●	-
	DT04-2PG-S-10/TXL	100000248	P	2	10 m	●	●	●
	DT04-2PG-A-2/TXL	100000388	P	2	2 m	-	●	-
	DT04-2PG-A-5/TXL	100000389	P	2	5 m	-	●	-
	DT04-2PG-A-10/TXL	100000390	P	2	10 m	-	●	-

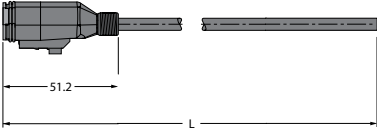
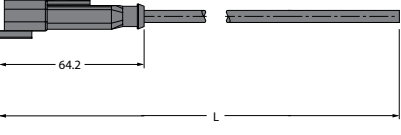

Products are linked with further information.

	Type code	ID	Connector S = Female P = Male	Number of pins/ Number of wires	Cable length	LED/suppressor circuit	Protective tube thread	Stock item
	DT06-3S-S-2/TXL	100000391	S	3	2 m	●	-	-
	DT06-3S-S-5/TXL	100000392	S	3	5 m	●	-	-
	DT06-3S-S-10/TXL	100000393	S	3	10 m	●	-	-
	DT06-3S-A-2/TXL	100000367	S	3	2 m	-	-	●
	DT06-3S-A-5/TXL	100000398	S	3	5 m	-	-	-
	DT06-3S-A-10/TXL	100000399	S	3	10 m	-	-	●
	DT06-3SG-S-2/TXL	100000395	S	3	2 m	●	●	●
	DT06-3SG-S-5/TXL	100000396	S	3	5 m	●	●	-
	DT06-3SG-S-10/TXL	100000397	S	3	10 m	●	●	●
	DT06-3SG-A-2/TXL	100000419	S	3	2 m	-	●	-
	DT06-3SG-A-5/TXL	100000420	S	3	5 m	-	●	-
	DT06-3SG-A-10/TXL	100000423	S	3	10 m	-	●	-
	DT04-3 P-S-2/TXL	100000427	P	3	2 m	●	-	-
	DT04-3P-S-5/TXL	100000428	P	3	5 m	●	-	-
	DT04-3P-S-10/TXL	100000429	P	3	10 m	●	-	-
	DT04-3P-A-2/TXL	100000433	P	3	2 m	-	-	●
	DT04-3P-A-5/TXL	100000434	P	3	5 m	-	-	-
	DT04-3P-A-10/TXL	100000435	P	3	10 m	-	-	●
	DT04-3PG-S-2/TXL	100000430	P	3	2 m	●	●	●
	DT04-3PG-S-5/TXL	100000431	P	3	5 m	●	●	-
	DT04-3PG-S-10/TXL	100000432	P	3	10 m	●	●	●
	DT04-3PG-A-2/TXL	100000436	P	3	2 m	-	●	-
	DT04-3PG-A-5/TXL	100000437	P	3	5 m	-	●	-
	DT04-3PG-A-10/TXL	100000438	P	3	10 m	-	●	-



Products are linked with further information.

Deutsch Connectors – DT Series

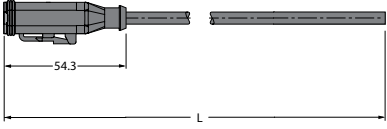
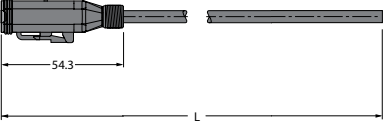
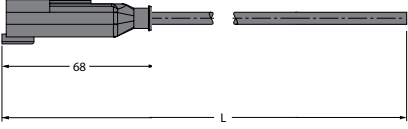
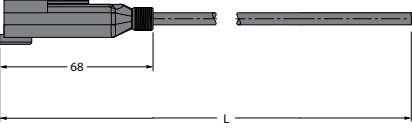
	Type code	ID	Connector S = Female P = Male	Number of pins/ Number of wires	Cable length	LED/suppressor circuit	Protective tube thread	Stock item
	DT06-4S-A-2/TXL	100000439	S	4	2 m	-	-	●
	DT06-4S-A-5/TXL	100000440	S	4	5 m	-	-	-
	DT06-4S-A-10/TXL	100000441	S	4	10 m	-	-	●
	DT06-4SG-A-2/TXL	100000442	S	4	2 m	-	●	-
	DT06-4SG-A-5/TXL	100000443	S	4	5 m	-	●	-
	DT06-4SG-A-10/TXL	100000444	S	4	10 m	-	●	-
	DT04-4P-A-2/TXL	100000445	P	4	2 m	-	-	●
	DT04-4P-A-5/TXL	100000446	P	4	5 m	-	-	-
	DT04-4P-A-10/TXL	100000447	P	4	10 m	-	-	●
	DT04-4PG-A-2/TXL	100000448	P	4	2 m	-	●	-
	DT04-4PG-A-5/TXL	100000449	P	4	5 m	-	●	-
	DT04-4PG-A-10/TXL	100000450	P	4	10 m	-	●	-

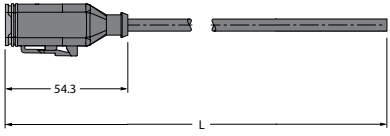
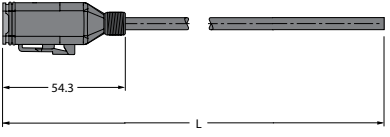
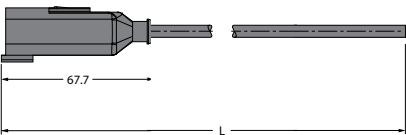
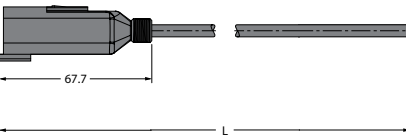

Products are linked with further information.

	Type code	ID	Connector S = Female P = Male	Number of pins/ Number of wires	Cable length	LED/suppressor circuit	Protective tube thread	Stock item
	DT06-6S-A-2/TXL	100000451	S	6	2 m	-	-	●
	DT06-6S-A-5/TXL	100000452	S	6	5 m	-	-	-
	DT06-6S-A-10/TXL	100000453	S	6	10 m	-	-	●
	DT06-6SG-A-2/TXL	100000454	S	6	2 m	-	●	-
	DT06-6SG-A-5/TXL	100000455	S	6	5 m	-	●	-
	DT06-6SG-A-10/TXL	100000456	S	6	10 m	-	●	-
	DT04-6P-A-2/TXL	100000457	P	6	2 m	-	-	●
	DT04-6P-A-5/TXL	100000458	P	6	5 m	-	-	-
	DT04-6P-A-10/TXL	100000459	P	6	10 m	-	-	●
	DT04-6PG-A-2/TXL	100000460	P	6	2 m	-	●	-
	DT04-6PG-A-5/TXL	100000461	P	6	5 m	-	●	-
	DT04-6PG-A-10/TXL	100000462	P	6	10 m	-	●	-



Products are linked with further information.

Deutsch Connectors – DT Series

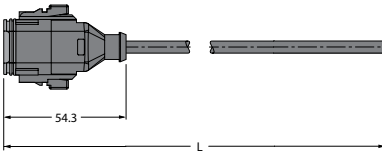
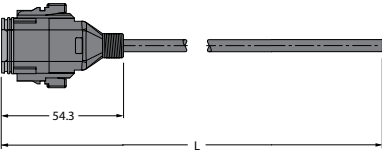
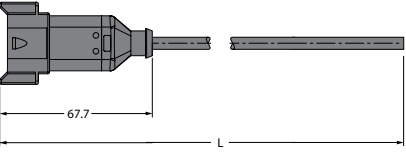
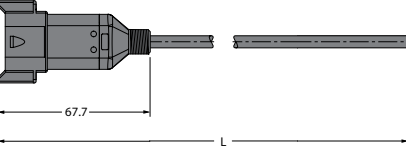
	Type code	ID	Connector S = Female P = Male	Number of pins/ Number of wires	Cable length	LED/suppressor circuit	Protective tube thread	Stock item
	DT06-8S-A-2/TXL	100000463	S	8	2 m	-	-	●
	DT06-8S-A-5/TXL	100000464	S	8	5 m	-	-	-
	DT06-8S-A-10/TXL	100000465	S	8	10 m	-	-	●
	DT06-8SG-A-2/TXL	100000466	S	8	2 m	-	●	-
	DT06-8SG-A-5/TXL	100000467	S	8	5 m	-	●	-
	DT06-8SG-A-10/TXL	100000468	S	8	10 m	-	●	-
	DT04-8P-A-2/TXL	100000469	P	8	2 m	-	-	●
	DT04-8P-A-5/TXL	100000470	P	8	5 m	-	-	-
	DT04-8P-A-10/TXL	100000471	P	8	10 m	-	-	●
	DT04-8PG-A-2/TXL	100000472	P	8	2 m	-	●	-
	DT04-8PG-A-5/TXL	100000473	P	8	5 m	-	●	-
	DT04-8PG-A-10/TXL	100000474	P	8	10 m	-	●	-

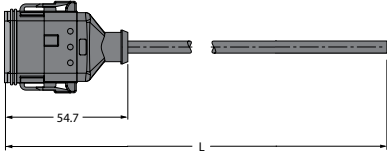
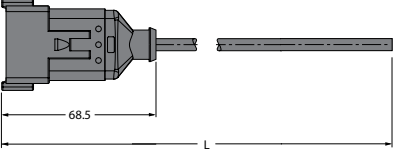

Products are linked with further information.

	Type code	ID	Connector S = Female P = Male	Number of pins/ Number of wires	Cable length	LED/suppressor circuit	Protective tube thread	Stock item
	DT06-12S-A-2/TXL	100000475	S	12	2 m	-	-	●
	DT06-12S-A-5/TXL	100000476	S	12	5 m	-	-	-
	DT06-12S-A-10/TXL	100000477	S	12	10 m	-	-	●
	DT04-12P-A-2/TXL	100000478	S	12	2 m	-	-	●
	DT04-12P-A-5/TXL	100000479	S	12	5 m	-	-	-
	DT04-12P-A-10/TXL	100000480	S	12	10 m	-	-	●



Products are linked with further information.

Superseal Connectors – TSS Series

Solutions for every application

Besides the Deutsch DT connector series, the Superseal TSS series connectors also offer an outstanding range of prefabricated and overmolded cables. These also meet the high requirements in terms of sealing and mechanical strength.

Essential features of the TSS series:

- made entirely from durable TPU (thermoplastic polyurethane)
- temperature resistance -40...+85 °C
- high sealing capacity thanks to silicon seals to IP67/IP69K
- overmolded cables
- halogen-free and flame-retardant



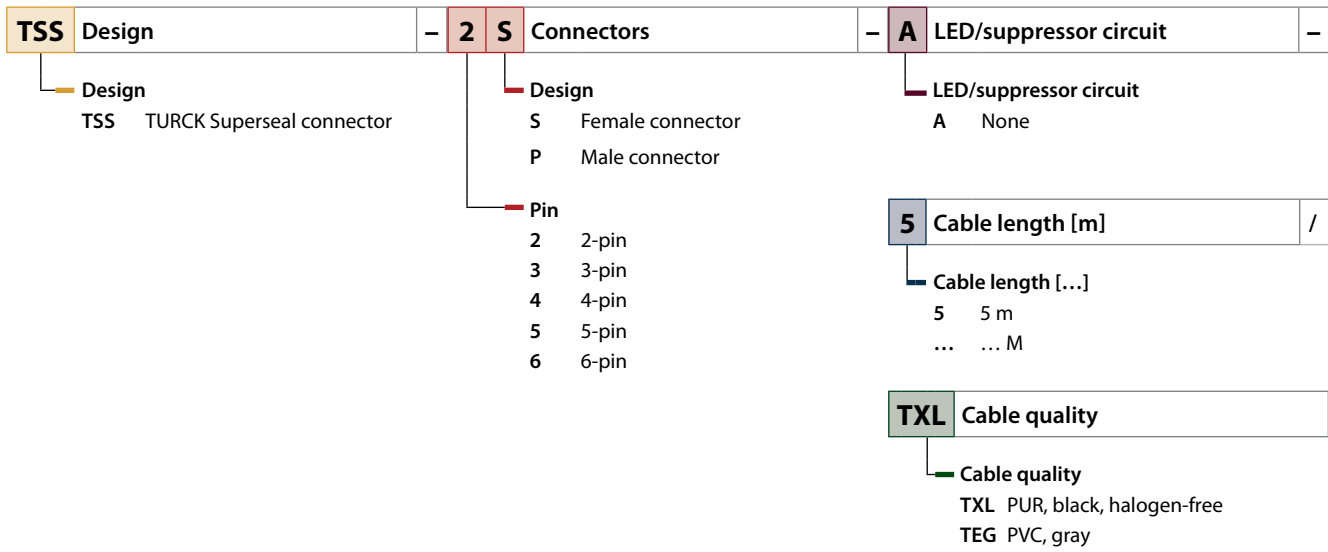

Type Code Superseal TSS Series

TSS - **2** **S** - **A** - **5** / **TXL**

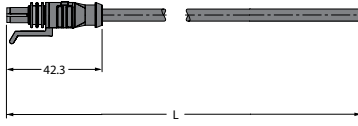

Superseal Connectors – TSS Series

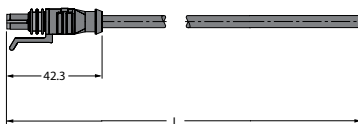
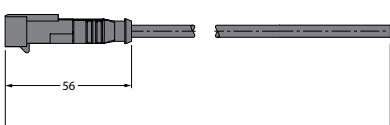
	Type code	ID	Connector S = Female P = Male	Number of pins/ Number of wires	Cable length	LED/suppressor circuit	Protective tube thread	Stock item
	TSS-2S-A-2/TXL	6936790	S	2	2 m	-	-	●
	TSS-2S-A-5/TXL	10000481	S	2	5 m	-	-	-
	TSS-2S-A-10/TXL	10000482	S	2	10 m	-	-	-
	TSS-2P-A-2/TXL	10000483	P	2	2 m	-	-	●
	TSS-2P-A-5/TXL	10000484	P	2	5 m	-	-	-
	TSS-2P-A-10/TXL	10000485	P	2	10 m	-	-	-
	TSS-3S-A-2/TXL	6936796	S	3	2 m	-	-	●
	TSS-3S-A-5/TXL	10000486	S	3	5 m	-	-	-
	TSS-3S-A-10/TXL	10000487	S	3	10 m	-	-	-
	TSS-3P-A-2/TXL	10000488	P	3	2 m	-	-	●
	TSS-3P-A-5/TXL	10000489	P	3	5 m	-	-	-
	TSS-3P-A-10/TXL	10000490	P	3	10 m	-	-	-



Products are linked with further information.

Type code	ID	Connector S = Female P = Male	Number of pins/ Number of wires	Cable length	LED/suppressor circuit	Protective tube thread	Stock item
TSS-4S-A-2/TXL	6936802	S	4	2 m	-	-	●
TSS-4S-A-5/TXL	100000491	S	4	5 m	-	-	-
TSS-4S-A-10/TXL	100000492	S	4	10 m	-	-	-
TSS-4P-A-2/TXL	100000493	P	4	2 m	-	-	●
TSS-4P-A-5/TXL	100000494	P	4	5 m	-	-	-
TSS-4P-A-10/TXL	100000495	P	4	10 m	-	-	-

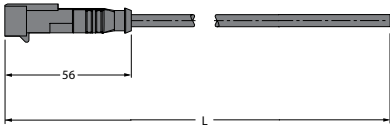
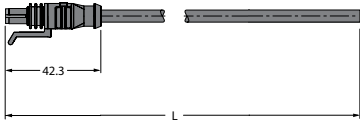

Type code	ID	Connector S = Female P = Male	Number of pins/ Number of wires	Cable length	LED/suppressor circuit	Protective tube thread	Stock item
TSS-5S-A-2/TXL	100000520	S	5	2 m	-	-	●
TSS-5S-A-5/TXL	100000521	S	5	5 m	-	-	-
TSS-5S-A-10/TXL	100000522	S	5	10 m	-	-	-
TSS-5P-A-2/TXL	100000523	P	5	2 m	-	-	●
TSS-5P-A-5/TXL	100000524	P	5	5 m	-	-	-
TSS-5P-A-10/TXL	100000525	P	5	10 m	-	-	-

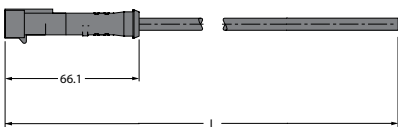
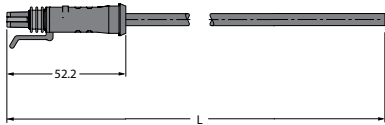

Products are linked with further information.

Superseal Connectors – TSS Series

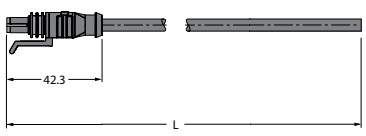
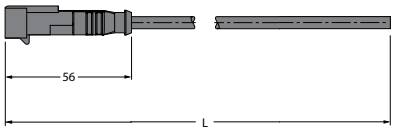
	Type code	ID	Connector S = Female P = Male	Number of pins/ Number of wires	Cable length	LED/suppressor circuit	Protective tube thread	Stock item
	TSS-6S-A-2/TXL	10000526	S	6	2 m	-	-	●
	TSS-6S-A-5/TXL	10000527	S	6	5 m	-	-	-
	TSS-6S-A-10/TXL	10000528	S	6	10 m	-	-	-
	TSS-6P-A-2/TXL	10000529	P	6	2 m	-	-	●
	TSS-6P-A-5/TXL	10000530	P	6	5 m	-	-	-
	TSS-6P-A-10/TXL	10000531	P	6	10 m	-	-	-



Products are linked with further information.

Y-Splitters for Deutsch/Superseal Applications

Modular design

As with the connector series, TURCK has also ensured the highest quality standards with its junction systems. The modular design allows a large number of variants for a wide range of applications.

The overmolded junction systems guarantee maximum protection from moisture penetration. Unlike the manually assembled junction systems permanent sealing is thus guaranteed. Another feature of the junction systems are the ready-to-use fixing holes that enable permanent vibration proof fastening.

You can also choose between 2, 3 and 4-way junctions. Each individual cable outlet can be configured individually. For this you can choose between different connectors (Deutsch, Superseal or also M12) and combine them as required. Each single cable can be adapted to the individual requirements of the particular application.

Essential features of the Y-splitter series:

- made entirely from durable TPU (thermoplastic polyurethane)
- temperature resistance -40...+85 °C
- high sealing capacity thanks to silicon seals to IP67/IP69K
- overmolded cables
- space saving
- cost efficient
- collection of multiple signals
- cable lengths and the number of pins can be selected as required
- combination of different connectors as required (DT, TSS, M12)
- fastening holes for fast and vibration proof mounting



Deutsch Y-Splitter

Type code	ID	Connector S = Female P = Male	Number of pins/ Number of wires	Cable length	LED/suppressor circuit	Protective tube thread	Stock item
DT04-4P-A-0.6-3DT06- 2S-A-0.6/0.6/0.6/TXL	100001126	S/P	4/2	0.6 m	-	-	●

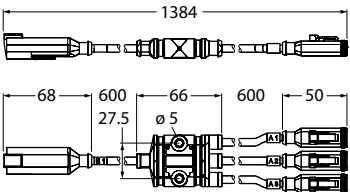

Superseal Y-Splitter

Type code	ID	Connector S = Female P = Male	Number of pins/ Number of wires	Cable length	LED/suppressor circuit	Protective tube thread	Stock item
TSS-3P-A-0.6-2TSS- 2S-A-0.6/0.6/TXL	100001125	S/P	3/2	0.6 m	-	-	●

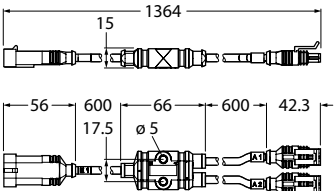

TURCK

Your Global Automation Partner

Over 30 subsidiaries and
60 representatives worldwide!

100000171 | 2018/04



#tuck | www.turck.com